



T4003EN

rev.0105

Audio
door entry system
Kits
with access control

Stadio Plus

Instructions manual

First of all we would like to thank and congratulate you for the purchase of this product manufactured by Golmar.

The commitment to reach the satisfaction of our customers is stated through the ISO-9001 certification and for the manufacturing of products like this one.

Its advanced technology and exacting quality control will do that customers and users enjoy with the legion of features this system offers. To obtain the maximum profit of these features and a properly wired installation, we kindly recommend you to expend a few minutes of your time to read this manual.

SYSTEM CHARACTERISTICS

- ☞ Audio system with 4 + N wires installation.
- ☞ Just 1 TF-104 transformer (12Va.c., 1.5A).
- ☞ Electronic call with acoustic acknowledgement signal.
- ☞ a.c. lock releases activation.
- ☞ Up to three telephones in the same apartment.
- ☞ Access control module with numeric keypad.
- ☞ 2 output relays of 8 activation codes each and independent panic code.
- ☞ 4, 5 or 6 digits programmable codes.
- ☞ Relay 1: n/c or n/o, single shoot or stable software programmable (60W maximum load).
- ☞ Relay 2: single shoot with three contacts (n/c or n/o with 60W maximum load).
- ☞ Programmable activation time from 1 to 20 seconds on single shoot mode.
- ☞ After introduction of consecutive wrong codes, the access control is disabled (more information on page 12, "System operation").

INDEX

Introduction.....	1	Telephone installation	11
System characteristics	1	Lock release installation	12
Index	1	Important note.....	12
Power supply installation.....	2	Starting recommendations.....	12
Door panel installation.....	2 to 4	System operation.....	12
Access control description	5	Installation diagrams	
Access control programming		Audio door entry system	13
Programming methodes	5	2nd relay connection	14
Enter and exit from programming	6	Parallel telephones installation.....	14
Programming structure and sequence.....	6	External lock release activation	14
Function fields and values	7 to 10	Quick programming guide	15
Duplicated codes.....	10	Troubleshooting hints.....	17

POWER SUPPLY INSTALLATION

2

Installing the TF-104 transformer.

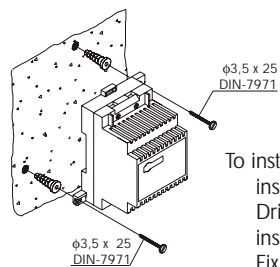

The transformer must be installed in a dry and protected place. It's recommended to protect the transformer by using a thermo-magnetic circuit breaker.

To install the transformer directly on the wall, insert the fixing flanges. Drill two holes of $\varnothing 6\text{mm}$ and insert the wallplugs. Fix the transformer with the specified screws.

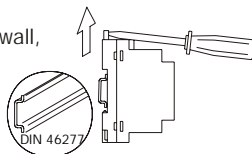

The transformer can be installed on a DIN guide (3 units) simply pressing it. To disassemble the transformer from the DIN guide, use a plain screwdriver to lever the flange as shown on the picture.

DOOR PANEL INSTALLATION

Embedding box positioning.

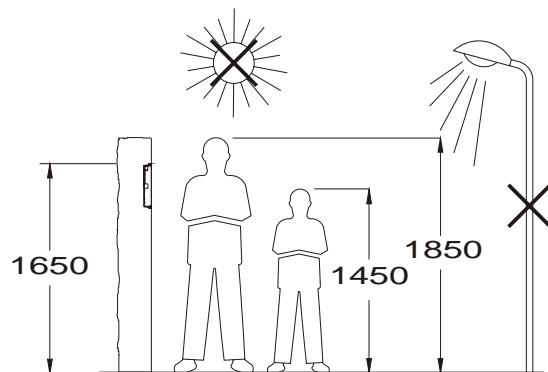

The upper part of the module should be placed at 1,65m. height roughly. The hole dimensions are: 125(W) x 257(H) x 57(D) mm.

The module has been designed to be placed under most of the environmental conditions. However it's recommended to take additional cautions like rainproof covers.

DOOR PANEL INSTALLATION

3

Preparing the embedding box.

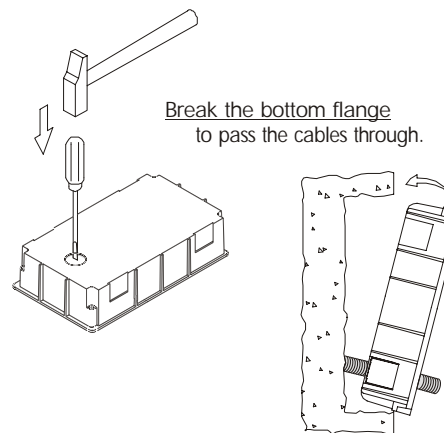

Pass the wiring through the hole made in the bottom part of the embedding box. Level and flush the embedding box. Once the embedding box is placed, remove the protective labels from the attaching door panel holes.

Hold the door panel on the embedding box.

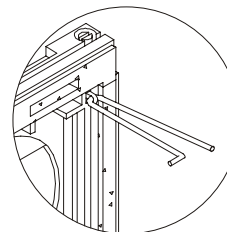

Select a direction to open the door panel; this selection should ease the door panel wiring. The opening direction will be settled through the hinges position, that must be passed through the header clips as shown. For example, if the hinges are placed on both clips of the lower header, the door panel will open downwards; if they are placed on the right clips of both headers, the door panel will open to left.

To hold the door panel on the embedding box, insert the hinges in the embedding box lockers as shown.

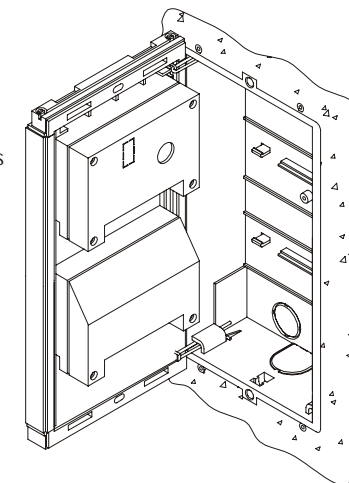
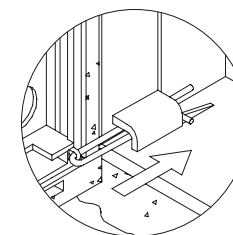

Place the nameplate labels.

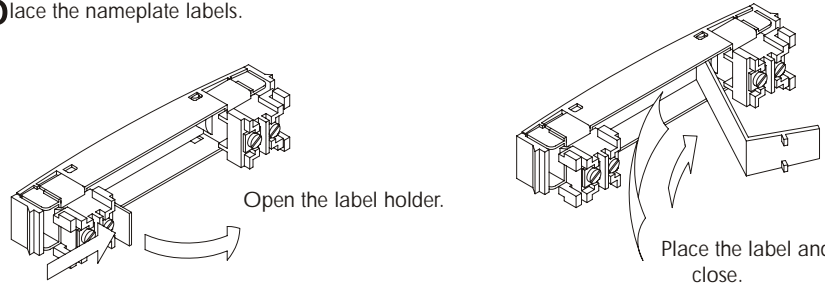

Open the label holder.

Place the label and close.

Final adjustments.

Once the nameplate labels are placed, wire the lamps from different modules and connect them to terminals L1 and L2 of the sound module, as it's shown on the installation diagrams.

If after starting the system it's considered that the audio volume isn't correct, proceed with the necessary adjustments as shown.

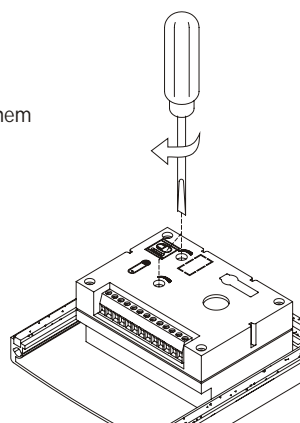

Close the door panel.

Fix the door panel by using the supplied screws.

Finish the door panel assembly by pressing the closing heads.

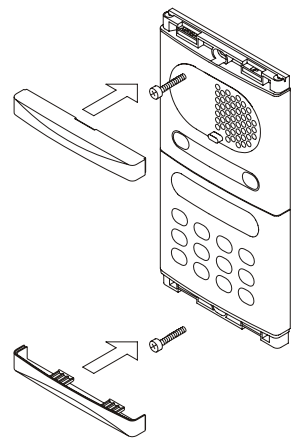

Module description



Installation terminal connector is located on the rear part of the module. The correspondance of each terminal is as follows:

- ~, ~ : power supply input.
- B+ : positif for battery.
- B- : negatif for battery.
- C1 : relay 1 common terminal.
- N1 : relay 1 output terminal.
- NC2 : relay 2 normally closed output.
- C2 : relay 2 common terminal.
- NA2 : relay 2 normally closed output.
- P : panic output.

Jumper JP4, that's placed on the left side of the terminal connector allows to reset the installer PIN code to the factory default (see page 6). Use this function only in case to forget this code. With the system switched on, change the jumper position to reset the code and return it to the standby position.

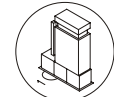

Reset.

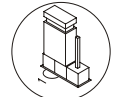

Standby.

Programming methodes.

It will be necessary to enter into the programming menu to configure the system properties. Two different programming menues are available: installer, that allows to modify any of the system properties and user, that only allows to change the relay activation codes, the user code and to disable the keypad acknowledgement signal.

Programming options with black text and white background are availables in both menues; options with white text and black background are only availables on installer menu.

The module will automatically exit from the configuration menu after 2 minutes with no operation.

Enter and exit from programming.



To enter into the programming menu, press key symbol and enter the installer PIN code (factory default: 271828) or the user PIN code (factory default: 314159).
To exit from the programming menu press key symbol at any moment. On both cases, the module will reproduce 5 fast acoustic tones.

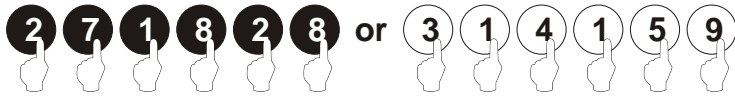

Programming structure and sequence.

To program the access control functions, it will be necessary to enter the function field followed by the corresponding value. Sometimes, this value will be predefined (i.e. relay 1 contact type) and sometimes will be selected by the installer. Once into programming mode, the programming sequence is as follows:

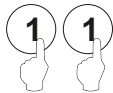

Enter the function field to be programmed: this is a 2 digits code. The module will reproduce a 2 slow acoustic tones.

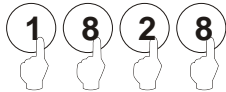

Enter the value of the function under programming. Once the value has been entered, the module will reproduce a 4 slow acoustic tones. Enter the next function field to be programmed or press key symbol to exit from the programming mode.

If a wrong value has been introduced, press cancel key (C). The keypad will reproduce 1 large acoustic tone. If cancel key has been pressed during the introduction of the function field, even after the confirming tones, the function field must be entered again; if cancel key has been pressed during the introduction of the function value, introduce a new value.

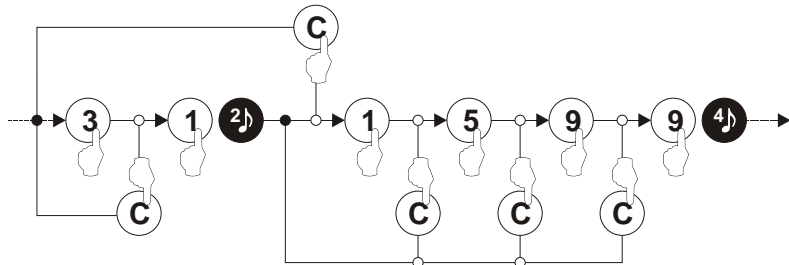

Function fields and values.

The module is delivered with factory default values: for security reasons, the relay activation codes are delivered with a non valid value. For a proper system operation, check that all the values match your requirements. It's not necessary to program the functions in the same order as they are shown.

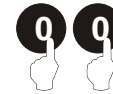

It defines the length of the relay activation codes. Accepted lengths are 4, 5 or 6 digits. Factory default: 4 digits. Any modification of this value will delete the existing relay activation codes.

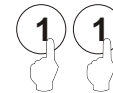
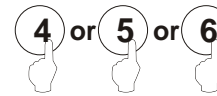

It defines the 1st activation code of the relay n.1. Enter a code according with the number of digits defined on 00 field.

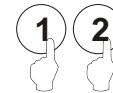

It defines the 2nd activation code of the relay n.1. Proceed as detailed on 11 field.

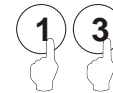

It defines the 3rd activation code of the relay n.1. Proceed as detailed on 11 field.

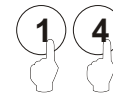

It defines the 4th activation code of the relay n.1. Proceed as detailed on 11 field.

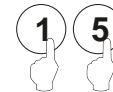

It defines the 5th activation code of the relay n.1. Proceed as detailed on 11 field.

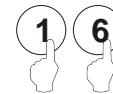

It defines the 6th activation code of the relay n.1. Proceed as detailed on 11 field.

Coming from previous page

Function fields and values.

It defines the 7th activation code of the relay n.1.
Proceed as detailed on 11 field.

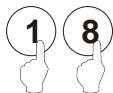

It defines the 8th activation code of the relay n.1.
Proceed as detailed on 11 field.

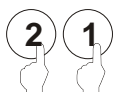

It defines the 1st activation code of the relay n.2.
Proceed as detailed on 11 field.



It defines the 2nd activation code of the relay n.2.
Proceed as detailed on 11 field.



It defines the 3rd activation code of the relay n.2.
Proceed as detailed on 11 field.



It defines the 4th activation code of the relay n.2.
Proceed as detailed on 11 field.



It defines the 5th activation code of the relay n.2.
Proceed as detailed on 11 field.



It defines the 6th activation code of the relay n.2.
Proceed as detailed on 11 field.



It defines the 7th activation code of the relay n.2.
Proceed as detailed on 11 field.



It defines the 8th activation code of the relay n.2.
Proceed as detailed on 11 field.

Continue

Coming from previous page

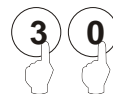
Function fields and values.

It defines the activation code of the panic function.
Proceed as detailed on 11 field.



It defines the contact type of the relay n.1.
Select 0 for normally open operation.
Select 1 for normally closed operation.
In case of power supply failure and n/c operation,
the relay will switch to n/o status.
Factory default: 0 (n/o).

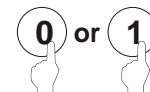

It defines the activation type of the relay n.1.
Select 0 for single shoot operation.
Select 1 for stable operation.
Factory default: 0 (single shoot).

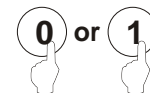

It defines the activation time of the relay n.1.
Only valid when programmed as single shoot.
Select a value from 01 to 20 (seconds).
Factory default: 03 seconds.

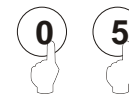

It defines the activation time of the relay n.2.
This relay only operates as single shoot.
Select a value from 01 to 20 (seconds).
Factory default: 03 seconds.

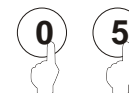

It defines the activation time of the panic output.
Select a value from 01 to 20 (seconds).
Factory default: 03 seconds.

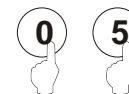

Continue

Coming from previous page

Function fields and values.



It defines the installer PIN code to enter into programming mode.
A 6 digits code must be always used. Once this code has been introduced, 2 acoustic tones will be heard: introduce the code again and 4 slow acoustic tones will be heard to confirm the changes.
Factory default: 271828.

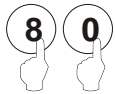

It defines the user PIN code to enter into programming mode.
A 6 digits code must be always used. Once this code has been introduced, 2 acoustic tones will be heard: introduce the code again and 4 slow acoustic tones will be heard to confirm the changes.
Factory default: 314159.

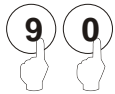

It allows to enable or disable the acoustic signal that's reproduced when a key is pressed. This function hasn't effect during programming mode.
Select 0 to disable this function.
Select 1 to enable this function.
Factory default: 1 (enabled).

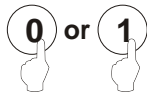

Duplicated codes.

It's possible to activate both relays simultaneously. Simply repeat one of the activation codes for both relays.

On systems that use the power supply included on the kit to activate the connected devices (i.e. two lock releases) simultaneously, the maximum load of this power supply must be calculated. If necessary, an additional power supply can be used to activate these devices. The connection of an additional TF-104 transformer, to activate a second lock release, is shown on page 14.

Description of the T-902 telephone.



- a. Telephone handset.
- b. Speaker grille.
- c. Microphone hole.
- d. Subjection hole.
- e. Telephone cord connectors.
- f. Additional push button.
- g. Door release push button.
- h. Hook switch.

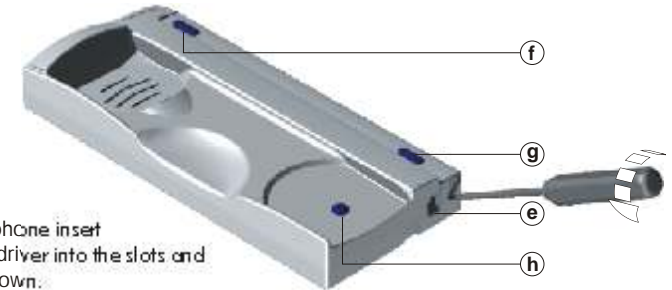

To open the telephone insert a plain screwdriver into the slots and rotate it as shown.

Avoid to place the telephone near to heating sources, in dusty locations or smoky environments.
The telephone can be fixed using an electrical embedding box or directly on the wall, as shown on the picture.
If the telephone will be installed directly over the wall, drill two holes of Ø6mm. on the specified positions, using 6mm. wallplugs and Ø3,5 x 25mm. screws.

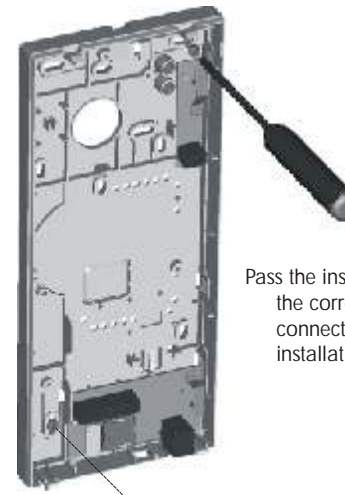

Pass the installation wires through the corresponding hole and connect them as shown on the installation diagrams.



Close the telephone as shown on the picture. Once the telephone is closed, connect the handset using the telephone cord and put it on the cradle.

Lock release installation.

If the lock release will be installed in a metal door, use a $\varnothing 3,5\text{mm}$. drill and tap the hole. In case of wood door, use a $\varnothing 3\text{mm}$. drill.

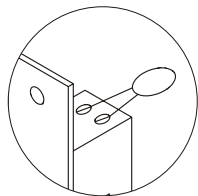

IMPORTANT.

A varistor is supplied with the access control module. To ensure a proper system operation, place the varistor on the lock release terminals directly, as shown on the left figure.

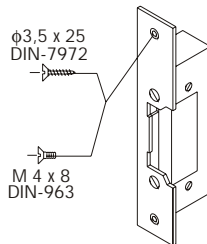

STARTING RECOMMENDATIONS

- ⇨ Do not use excessive force when tightening the transformer connector screws.
- ⇨ Install the equipment without the power connected. Disconnect from power before any system modification. Check that the input voltage is lower than 230Va.c.
- ⇨ Before to connect the system, check the connections between door panel and telephones, and the transformer connection. Do always follow the enclosed information.

SYSTEM OPERATION

- ⇨ To make a call the visitor should press the push button corresponding to the apartment he wishes to contact. An acoustic tone will be heard confirming the call as the push button is pressed. At this moment the call will be received at the telephone in the dwelling.
- ⇨ To establish communication pick up the telephone handset.
- ⇨ To open the door, press the door release push button at any moment.
 - ☞ Press the door release telephone push button at any moment.
 - ☞ Key in a valid code on the access control: in case of a valid code, three acoustic tones will be reproduced and the lock release will be activated. In case of a wrong code, a long acoustic tone will be heard. After introduction of three consecutive wrong codes, in a period of less than 15 seconds, the access control is disabled during 3 minutes. After this time, if 3 consecutive wrong codes are introduced again, the disabled time is doubled up to a maximum of 12 minutes.

Audio door entry system.

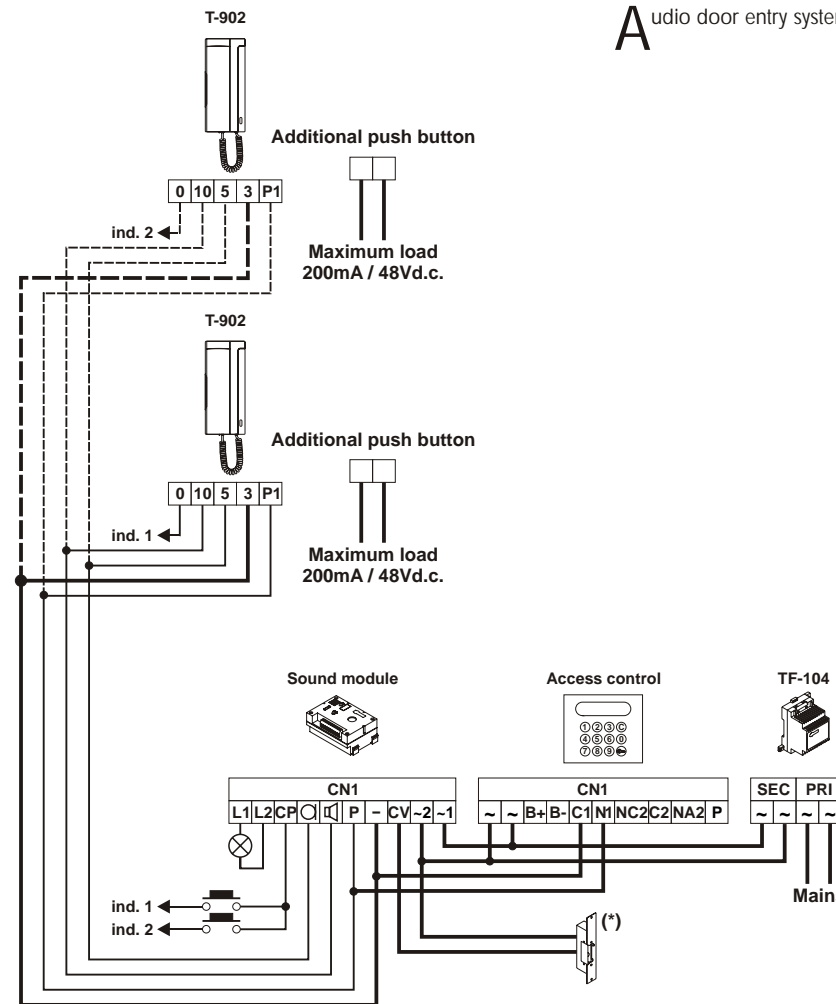

Terminal	Sections chart	
	100m.	300m.
0, ind, 5, 3, 10, 5, P, P1	0,25mm ²	0,50mm ²
-, 3	0,50mm ²	1,00mm ²
~1, ~2, CV	1,00mm ²	2,50mm ²

(*) Place the varistor on the lock release terminals directly.

2nd relay connection.

Relay nr. 1 is reserved for the connection of the door panel lock release, as it's shown on previous page. Relay nr. 2 operates on single shoot mode only. Use a TF-104 transformer to connect a 2nd lock release; wire them as it's shown on the enclosed diagram. To activate the 2nd lock release from the telephone, wire the telephone additional push button between C2 and NA2 access control terminals. (*) Place the varistor on the lock release terminals directly.

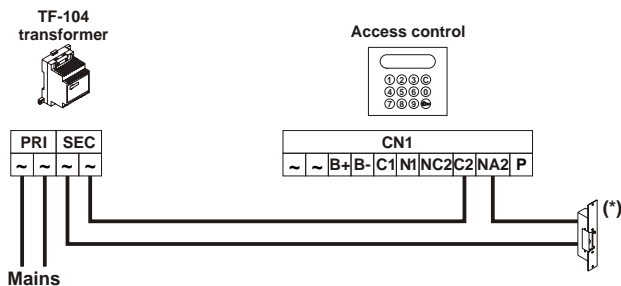

Parallel telephones installation.

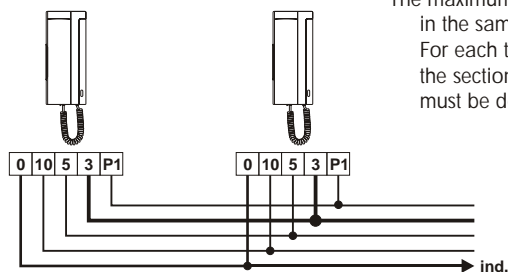

The maximum number of telephones placed in the same apartment is three. For each telephone placed in parallel the section corresponding to the call wire must be doubled.

External lock release activation.

The lock release can be activated at any moment by using an external push button, that must be connected between '-' and 'P' terminals of the main module. This function will allow to exit from the building being not necessary the use of a key.

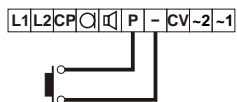

Quick programming guide.

0 0	4	Codes length (4, 5 or 6 digits)
1 1		1st code, Relay 1
1 2		2nd code, Relay 1
1 3		3rd code, Relay 1
1 4		4th code, Relay 1
1 5		5th code, Relay 1
1 6		6th code, Relay 1
1 7		7th code, Relay 1
1 8		8th code, Relay 1
2 1		1st code, Relay 2
2 2		2nd code, Relay 2
2 3		3rd code, Relay 2
2 4		4th code, Relay 2
2 5		5th code, Relay 2
2 6		6th code, Relay 2
2 7		7th code, Relay 2
2 8		8th code, Relay 2
3 0		Panic code
4 1	0	Relay 1: N/O (0) N/C(1)
5 1	0	Relay 1: Single shoot (0) Stable(1)
6 1	0 3	Relay 1: Activation time (01 to 20s.)
6 2	0 3	Relay 2: Activation time (01 to 20s.)
6 3	0 3	Panic: Activation time (01 to 20s.)
7 0	2 7 1 8 2 8	Installer PIN code
8 0	3 1 4 1 5 9	User PIN code
9 0	1	Keypad tones: Off (0) On(1)

Gray text: factory default

- ☞ Nothing operates.
 - ☞ Check the output transformer voltage between SEC terminals: it should have 12 to 17Va.c. If not, disconnect the transformer from the installation and measure again. If it's correct now, it means there is a short circuit in the installation: disconnect the transformer from mains and check the installation.
- ☞ Inappropriate audio level.
 - ☞ Adjust the level volumes as shown on page 4. In case of feedback, reduce the audio levels until feedback fade out.
- ☞ Door open function no operates.
 - ☞ Disconnect the lock release from the sound module and short-circuit terminals '-' and 'P': at that moment the output voltage between terminals 'CV' and '~2' of the sound module should be 12Va.c. If it's so check the lock release, its wiring and the wiring of the terminal 'P' from the sound module to the telephones. If these tests don't solve the problem, replace the sound module.
 - ☞ Check that the introduced code is a valid code to activate the relay connected to the lock release.
- ☞ No telephones receive the call or acknowledgement call signal is not reproduced.
 - ☞ Check that the push buttons common terminal are correctly connected to the 'CP' terminal of the sound module.



golmar@golmar.es
www.golmar.es



Golmar se reserva el derecho a cualquier modificación sin previo aviso.
Golmar se réserve le droit de toute modification sans préavis.
Golmar reserves the right to make any modifications without prior notice.