



T4502EN

rev.0104

Stand alone
proximity reader
access control

Stadio Plus

*Control de access ~ Control de access ~ Control de access ~ Zutrittskontrolle
Access control ~ Toegangskontrolle ~ Zutrittskontrolle*

Instructions manual

First of all we would like to thank and congratulate you for the purchase of this product manufactured by Golmar.

The commitment to reach the satisfaction of our customers is stated through the ISO-9001 certification and for the manufacturing of products like this one.

Its advanced technology and exacting quality control will do that customers and users enjoy with the legion of features this system offers. To obtain the maximum profit of these features and a properly wired installation, we kindly recommend you to expend a few minutes of your time to read this manual.

SYSTEM CHARACTERISTICS

- ☞ Stand alone access control module with proximity reader.
- ☞ Compatible with PROXCARD ISO cards and NEOKEY key holders.
- ☞ Aproximate reading distance: 7cm.
- ☞ Up to 500 users in one or several memory addresses.
- ☞ 12Va.c. and 18Vd.c. inputs.
- ☞ Possibility to be combined with any of the 'Stadio Plus' system installations or C4Plus access control systems.
- ☞ 1 single shoot output relay with 3 seconds activation time.

INSTALLATION WITH 'STADIO PLUS' PANELS

- ☞ When combined on 'Stadio Plus' door panels, follow the assembly instructions supplied with the door panel. Wire and program the access control module as it's explained in this instructions manual.

INDEX

| | | | |
|--|--------|--|--------|
| Introduction | 1 | Module programming | |
| System characteristics | 1 | IP operation mode | 4 to 5 |
| Installation with 'Stadio Plus' panels | 1 | Users validation | 5 |
| Index | 1 | C4Plus operation mode | 6 |
| Module installation | 2 to 3 | Lock release installation | 7 |
| Module description | 3 | <u>Important notice</u> | 7 |
| | | Installation diagrams | |
| | | Stand alone operation | 8 |
| | | Combined on 'Stadio Plus' panels | 8 to 9 |

E mbedding box positioning.

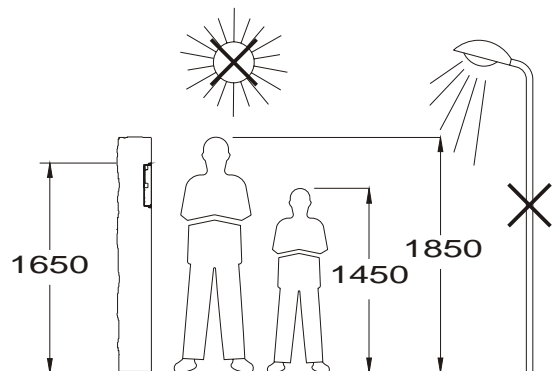

The upper part of the module should be placed at 1,65m. height roughly.
The hole dimensions are: 125(W) x 140(A) x 57(D) mm.

The module has been designed to be placed under most of the environmental conditions.
However it's recommended to take additional cautions like rainproof covers.

P reparing the embedding box.

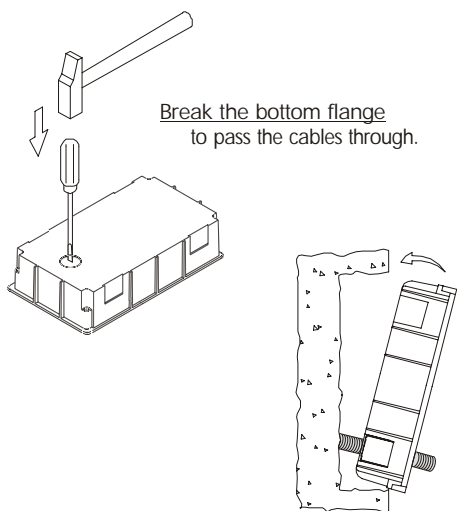

Pass the wiring through the hole made in the bottom part of the embedding box. Level and flush the embedding box. Once the embedding box is placed, remove the protective labels from the attaching door panel holes.

H old the module on the embedding box.

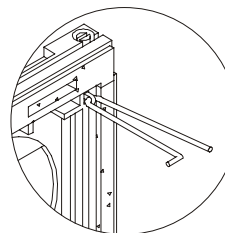

Select a direction to open the module; this selection should ease the door panel wiring.
The opening direction will be settled through the hinges position, that must be passed through the header clips as shown.
For example, if the hinges are placed on both clips of the lower header, the module will open downwards; if they are placed on the right clips of both headers, the module will open to left.

To hold the module on the embedding box, insert the hinges in the embedding box lockers as shown.

Fix the module by using the supplied screws.
Finish the module assembly by pressing the closing heads.

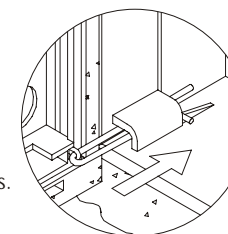

M odule description



Installation terminal connector is located under the module protection cover. The correspondence of each terminal is as follows:

- + , - : power supply input.
- S : data (only C4Plus mode).
- 1 : relay common terminal.
- 2 : relay output.

The jumper placed on the right side of the 7 segments display allows to select between two operation modes:
IP (stand alone mode or to be used with "Stadio Plus" panels) or C4P. C4P mode is to be used with C4Plus access control systems only.

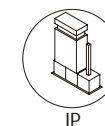

IP operation mode.



IP mode allows to use this module in combination with "Stadio Plus" panels, or to operate as stand alone module. The operation mode selection is shown on page 3.

To enter into programming mode, a PIN code will be required. This code of three digits length (override digit zero from left) is stuck on the relay, placed on the left side of the display. While programming, the led on the front part of the module will light red. To exit from the programming mode, wait 20 sec. from the last operation.



Press C button during 2 seconds.
The left digit display will show number 0.



Press arrow "UP" button till the first PIN digit will appears on the display.



Press arrow "DOWN" button to move to the next digit.
The left display will turn off and the center display will show number 0.



Press arrow "UP" button till the second PIN digit will appears on the display.



Press arrow "DOWN" button to move to the next digit.
The center display will turn off and the right display will show number 0.



Press arrow "UP" button till the last PIN digit will appears on the display.

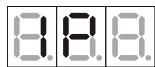

To validate the code, press C button during 2 seconds: the display will show the complete code.
In case of valid code, the display will show the selected operation mode (IP). In case of wrong code, the display will show the message "E-5" during 10 seconds and will automatically exit from the programming mode.

Validation of PROXCARD ISO cards or NEOKEY key holders.

IMPORTANT: this module is to be used with ISO cards or key holders supplied by Golmar. Other proximity items will be not accepted even if they have the same appearance.



Once a valid PIN code has been introduced, the display will show the 1st memory position.
Use "UP" and "DOWN" arrows to select the desired position, from 1 to 500.

Several cards or key holders can be recorded in one memory position. Remember that the maximum number of cards or key holders (users) is 500.



When the display shows the desired memory position, approach the card or key holder to be recorded. The display will show the number of cards recorded in this position (including the one you are recording). This number will be shown with a dot on its right bottom part. The display will show the selected memory position again.

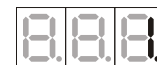

If you are trying to record an already existing card, the display will show the memory position where recorded, coming back to the position you are trying to record it.
Repeat the above steps to record the rest of cards.

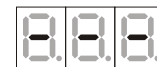
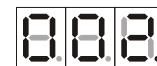

To erase existing cards from a specified memory position, use "UP" and "DOWN" arrows till the display shows the desired position. Press C button during 3 seconds: the display will show the number of cards recorded in this position and will confirm the progress by showing the message ---.
To erase all the existing cards, press C button during 15 seconds approximately: the display will show the message "IP" once the memory is empty.

The module will exit from the programming mode after 20 seconds of no operation.
The display and the led on the front part of the module will be turned off.

C4Plus operation mode.

Use this operation mode to connect the module to a C4Plus access control system.
In this case, the C4Plus relays will be activated instead of the module internal relay.

Use the PIN code to enter into programming mode, as it's described on page 4.

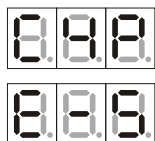

In case of valid code, the display will show the selected operation mode (C4P). In case of wrong code, the display will show the message "E-5" during 10 seconds and will automatically exit from the programming mode.

In this mode, the cards are recorded on the C4Plus memory instead of the memory module. DIRECTORPlus software will be necessary to manage the C4Plus memory. However, one of the C4Plus relays must be assigned to the proximity reader module.

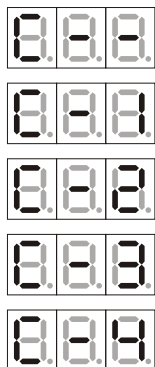

Use "UP" or "DOWN" arrows to select a C4Plus relay. The display will show the following messages: C-1 (relay 1), C-2 (relay 2), C-3 (relay 3) or C-4 (relay 4).

To exit from the programming mode, wait 20 sec. from the last operation.

Lock release installation.

If the lock release will be installed in a metal door, use a $\varnothing 3,5\text{mm}$. drill and tap the hole. In case of wood door, use a $\varnothing 3\text{mm}$. drill.

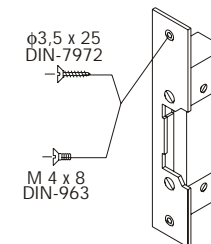

IMPORTANT: a varistor and a diode are supplied with this proximity reader. In case to connect an a.c. lock release, place the varistor on the lock release terminals directly. In case to connect an d.c. lock release, place the diode on the lock release terminals directly. Special attention on polarity is required.

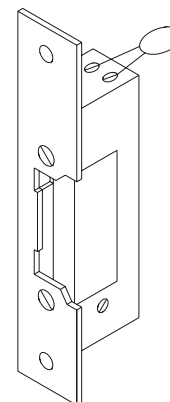

a.c. lock release

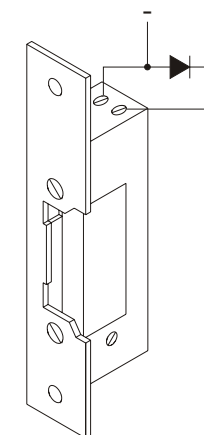

d.c. lock release



Stand alone operation.

The enclosed diagram uses a TF-104 transformer (12Va.c.) as access control module feeder.

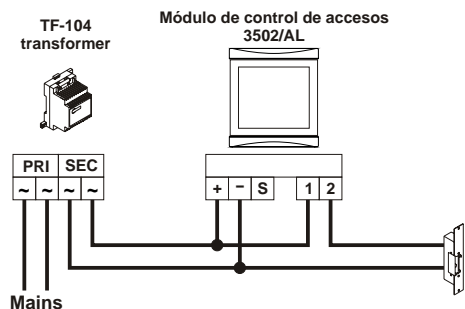

Combined on 'Stadio Plus' door panels.

One access door audio systems with 4 + 'n' installation.

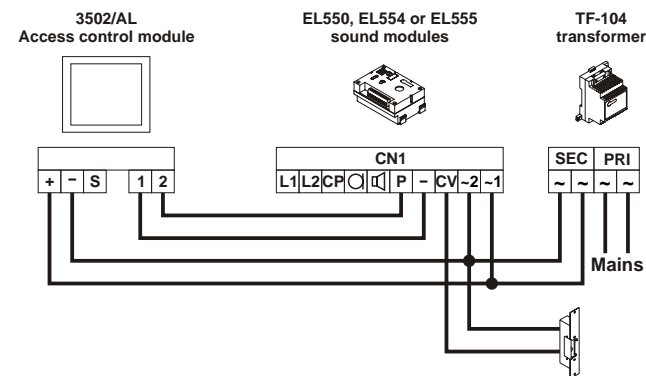

Several access doors systems with 4 + 'n' installation.

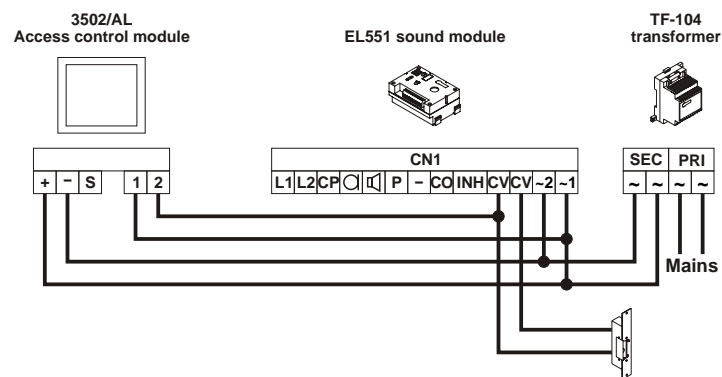

Combined on 'Stadio Plus' door panels.

The wiring of the access control module on 'Stadio Plus' door panels will depends on the installation type. Use the power supply connected to the door panel.

Audio and video systems with digital installation.

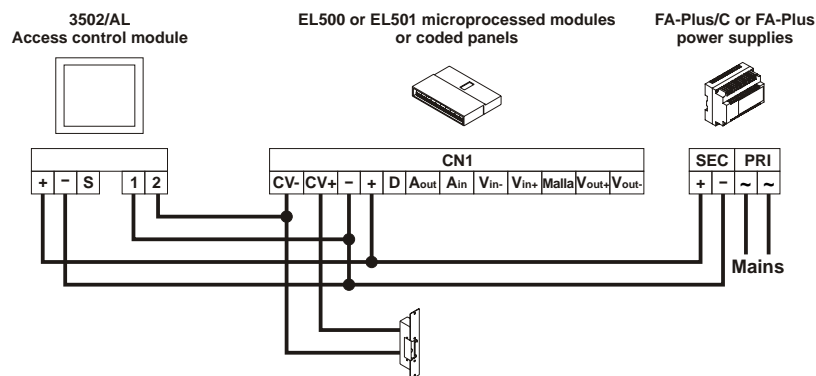



golmar@golmar.es
www.golmar.es



Golmar se reserva el derecho a cualquier modificación sin previo aviso.
Golmar se réserve le droit de toute modification sans préavis.
Golmar reserves the right to make any modifications without prior notice.