



# T562 GB2 TELEPHONE

## USER MANUAL



## INTRODUCTION

---

First and foremost we would like to thank you for purchasing this product.

Our commitment to achieving the satisfaction of customers like you is manifested through our ISO-9001 certification and the manufacture of products like the one you have just purchased.

Its advanced technology and strict quality control will ensure that customers and users enjoy the numerous features that this device offers. To get the most out of them and ensure proper operation from day one, we recommend that you read this instruction manual.

## CONTENTS

---

Introduction.....	2
Contents.....	2
Safety precautions.....	2
Characteristics.....	2
System operation.....	3
Description of the telephone.....	
Description.....	3
Function buttons.....	3
Connection terminals.....	3
Call volume control.....	3
Configuration DIP switch.....	4
Configuration of telephone address codes (up to 32 addresses).....	4-5
Configuration of telephone address codes (up to 128 addresses).....	5-8
'Doctor mode' function.....	8
Intercom function.....	8
Light activation function (staircase light).....	8
Configuration of ringtones.....	9
Installing the telephone.....	10
Wiring diagrams.....	11-12
Notes.....	13

## SAFETY PRECAUTIONS

---







- **Always disconnect the power supply** before making modifications to the device.
- The fitting and handling of these devices must be carried out by **authorised personnel**.
- The wiring must run at least **40cm away from any other wiring**.
- Do not overtighten the screws on the connector.
- Install the telephone in a dry protected location free from the risk of dripping or splashing water.
- Do not place in humid, dusty or smoky locations, or near sources of heat.
- Before connecting the device to the mains, check the connections between the door panel, power supply and telephones.
- Always follow the instructions contained in this manual.

## CHARACTERISTICS

---

- Telephone with simplified wiring (non-polarised 2 wire bus).
- Up to 4 telephones/monitors per apartment (master, slave 1, slave 2 and slave 3).
- Up to 32 apartments/telephones per installation.
- Up to 128 apartments/telephones per installation and maximum 1 telephone per apartment (**EL632 GB2A/EL642 GB2A sound module required**).
- Completely private conversation.
- Call volume control (high, medium or mute).
- Input for calls from the interior door of the apartment.
- Call repeater output (SAR-12/24).
- Different ringtones to identify the origin of the call (door panel, intercom or apartment door).
- Button  for lock release 1 activation.
- Button **AUX** for intercom/lock release 2/light activation (SAR-GB2 and SAR-12/24 modules required). **Important: Light activation function only with T-562 telephones V.03 and later.**
- Button for configuring ringtones (inside the telephone).
- DIP switches for configuring telephone address (call code), master/slave and end of line and activating 'doctor mode' function (automatic door opening). Inside the telephone.

**SYSTEM OPERATION**

- To make a call, the visitor needs to press the button for the apartment, an audible tone indicates that the call is being made and LED  on the door panel illuminates. If vocal synthesis is enabled, a 'Call is in progress' message appears indicating that a call is being made. At this moment, the apartment's telephone(s) receives the call. If another apartment is called by mistake, press the button for the correct apartment and the first call will be cancelled.
- The call lasts for 40 seconds. If the call is not answered within 40 seconds, LED  will turn off and the channel will be freed.
- To establish communication, lift the handset of any telephone in the apartment and door panel LED  will illuminate.
- Communication will last for one and a half minutes or until the handset is hung up. When communication has finished, LEDs  and  will turn off and the channel will be freed. If vocal synthesis is activated, a 'Communication is finished' message will indicate that the call is over.
- To open the door, press button  (if it exists and, to open the second door, press button **AUX**) during the call or communication processes: one press activates the lock release for five seconds and LED  on the door panel will also illuminate for five seconds. If vocal synthesis is enabled, a 'Door Opened!' message will be indicated on the door panel.
- Description of the function buttons can be found on p. 3.

**DESCRIPTION OF THE TELEPHONE**

**Description:**

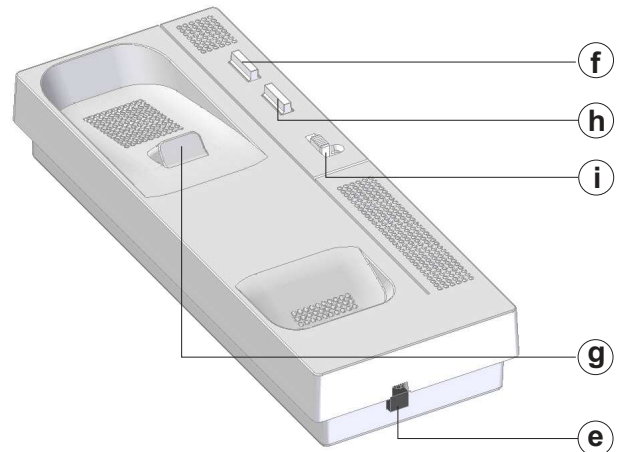

- a. Handset.
- b. Speaker grille
- c. Microphone hole.
- d. Subjection hole.
- e. Telephone cord connector.

- f. Door release button.
- g. Hook switch.
- h. Auxiliary function button.
- i. Volume control.

**Function buttons:**

 During call reception and communication processes, it enables lock release 1 to be activated.

**AUX** During call reception and communication processes, it enables lock release 2 to be activated.

System in standby:

- With the handset off the hook, it performs the intercom function.
- With the handset on the hook, it activates the light function (SAR-GB2 and SAR-12/24 modules required).

**Important: Light activation function only with T-562 telephones V.03 and later.**

**Description of connection terminals:**



- L1, L2:** Bus connection.
- HZ, -:** Door bell connection.
- SA, -:** Call repeater connection (SAR-12/24). (12Vdc/50mA maximum).

**Call volume control:**

The telephone has a call volume control which can be set to high, medium or mute.

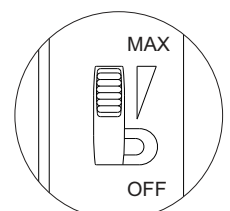

**DESCRIPTION OF THE TELEPHONE**

**Description of DIP switch and configuration of telephone address (code):**

**DIP 1 to DIP 5:** Configure telephone address (up to 32 addresses).

**DIP 1 to DIP 7:** With **DIP 10 set to ON**, it enables the telephone address to be configured (up to 128 addresses).

The switches set to the OFF position have a value of zero.

The values of the switches set to ON are shown in the table below.

The telephone code is the sum of the values of the switches set to ON.

**Table of values (DIP 10 to OFF)**

Switch number:	1	2	3	4	5
Value when ON:	1	2	4	8	16

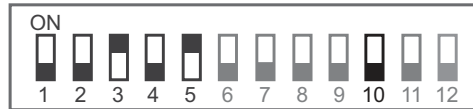

Example: 0 + 0 + 4 + 0 + 16 = 20

**Table of values (DIP 10 to ON)**

Switch number:	1	2	3	4	5	6	7
Value when ON:	1	2	4	8	16	32	64

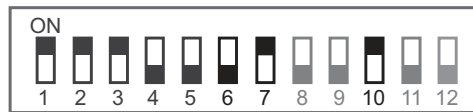

Example: 1 + 2 + 4 + 0 + 0 + 0 + 64 = 71

**DIP 8 and DIP 9:** Configure the telephone as master/slave. DIP 8 and DIP 9 to OFF master, DIP 8 to ON and DIP 9 to OFF slave 1, DIP 8 to OFF and DIP 9 to ON slave 2, DIP 8 and DIP 9 to ON slave 3. **If DIP 10 to ON, the telephone is always 'master'.**

**DIP 10:** Leave in the OFF position for installations of up to 32 telephones (DIP 6 and DIP 7 without function). Set to ON for installations of up to 128 telephones (**EL632 GB2A/EL642 GB2A sound module required**), DIP 8 and DIP 9 have no function, the telephone is always 'master' (maximum 1 telephone per apartment).

**DIP 11:** Configures the end of line. In installations with telephones only, it must always be in the OFF position. In mixed installations of monitors with telephones in the same apartment, set to ON for the telephones in which the Bus cable ends and leave in the OFF position for intermediate telephones.

**DIP 12:** Leaving it in the OFF position defines the OFF position of the volume control switch as 'mute'. Setting it to ON defines the OFF position of the volume control switch as 'doctor mode'.

**Configuration of telephone address codes (up to 32 addresses):**

**DIP 11:** Configures the end of line. In installations with telephones only, it must always be in the OFF position. In mixed installations of monitors with telephones in the same apartment, set to ON for the telephones in which the Bus cable ends and leave in the OFF position for intermediate telephones.

**DIP 11 to OFF**



**DIP 11 to ON**



**DIP 1 to DIP 5:** To configure the telephone/apartment address (up to 32 addresses) and **DIP 10 to OFF**.

**Apartment code 1 (\*)**



**Apartment code 2**



**Apartment code 3**



**Apartment code 4**



**Apartment code 5**



**Apartment code 6**

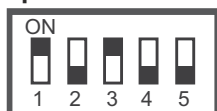

**Apartment code 7**

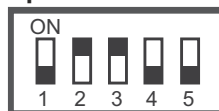

**Apartment code 8**

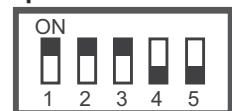

**Apartment code 9**



**Apartment code 10**



**Apartment code 11**

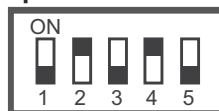

**Apartment code 12**

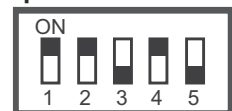

**IMPORTANT:** In coded panel systems (N3301/GB2), an EL632 GB2A/EL642 GB2A sound module is required and must be configured to 'operating mode 5' (see door panel manual).

(\*) -In door panel systems with call buttons, the first address on the telephone is 'Code 0' (see door panel manual).

-In coded panel systems (N3301/GB2), 'Code 0' is 'Code 32', which means that when a call is made to a telephone with 'Code 0' (DIP 1 to DIP 5 set to OFF), it needs to be entered **3 2** on the N3301/GB2 numeric keypad (see door panel manual).

-In the software (Address Manager GB2), 'Code 0' is also shown as 'Code 32'.

Continued overleaf

DESCRIPTION OF THE TELEPHONE

Continued from previous page.

Apartment code 13



Apartment code 14



Apartment code 15



Apartment code 16

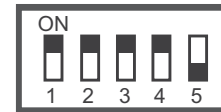

Apartment code 17



Apartment code 18



Apartment code 19



Apartment code 20

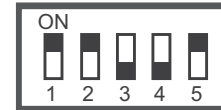

Apartment code 21



Apartment code 22



Apartment code 23



Apartment code 24

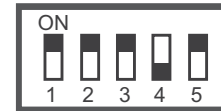

Apartment code 25

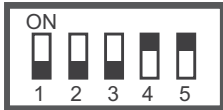

Apartment code 26



Apartment code 27



Apartment code 28

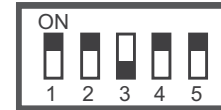

Apartment code 29



Apartment code 30



Apartment code 31



Apartment code 32

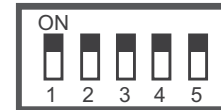

**Configuration of telephone address codes (up to 128 addresses):**

Up to 128 apartments/telephones per 'audio only' installation (EL632 GB2A/EL642 GB2A sound module required and button panel must be set to 'operating mode 2' or coded panel to 'operating mode 6', see corresponding door panel manual).

DIP 10 ON and DIP 11 OFF

DIP 10: Set to ON for 'audio only' installations of up to 128 telephones.

DIP 11: Configures the end of line. In installations with telephones only, it must always be in the OFF position.



DIP 1 to DIP 7: To configure the telephone/apartment address (up to 128 addresses).

Apartment code 1 (\*)



Apartment code 2

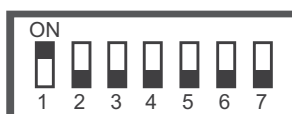

Apartment code 3

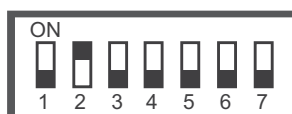

Apartment code 4



Apartment code 5

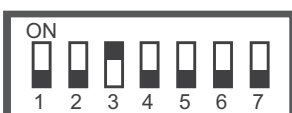

Apartment code 6

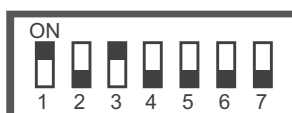

Apartment code 7

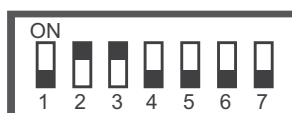

Apartment code 8



Apartment code 9



Apartment code 10

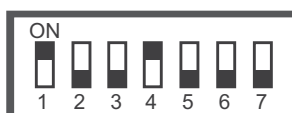

Apartment code 11

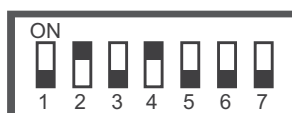

Apartment code 12



Apartment code 13

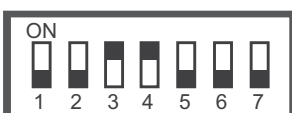

Apartment code 14

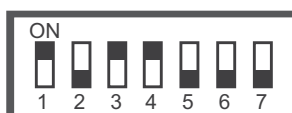

Apartment code 15

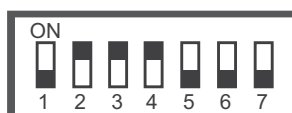

Apartment code 16



(\*) -In door panel systems with call buttons, the first address on the telephone is 'Code 0' (see door panel manual).  
 -In coded panel systems (N3301/GB2), 'Code 0' is 'Code 128', which means that when a call is made to a telephone with 'Code 0' (DIP 1 to DIP 7 set to OFF), it needs to be entered (1)(2)(8) on the N3301/GB2 numeric keypad (see door panel manual).  
 -In the software (Address Manager GB2), 'Code 0' is also shown as 'Code 128'.

Continued overleaf



DESCRIPTION OF THE TELEPHONE

Continued from previous page.

Apartment code 61



Apartment code 62



Apartment code 63



Apartment code 64

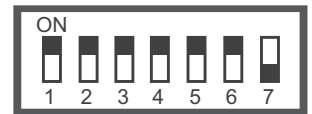

Apartment code 65



Apartment code 66



Apartment code 67



Apartment code 68



Apartment code 69



Apartment code 70



Apartment code 71



Apartment code 72



Apartment code 73



Apartment code 74



Apartment code 75



Apartment code 76



Apartment code 77

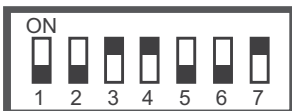

Apartment code 78

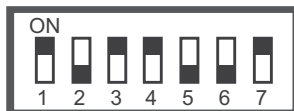

Apartment code 79



Apartment code 80

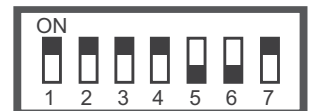

Apartment code 81



Apartment code 82

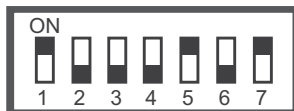

Apartment code 83

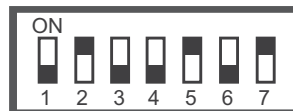

Apartment code 84



Apartment code 85

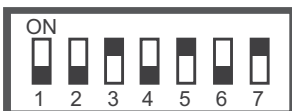

Apartment code 86

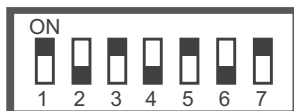

Apartment code 87

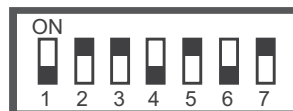

Apartment code 88

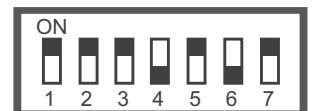

Apartment code 89

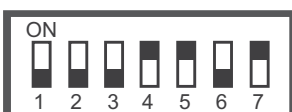

Apartment code 90

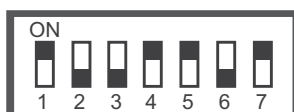

Apartment code 91



Apartment code 92



Apartment code 93



Apartment code 94

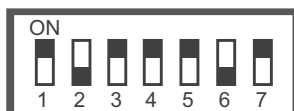

Apartment code 95

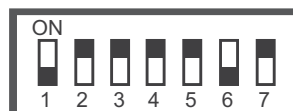

Apartment code 96

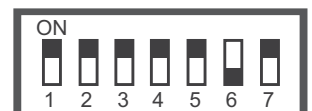

Apartment code 97



Apartment code 98



Apartment code 99



Apartment code 100



Apartment code 101



Apartment code 102

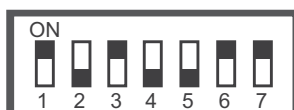

Apartment code 103

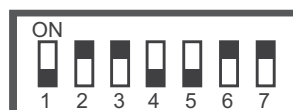



















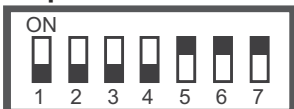

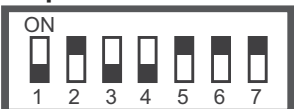

Apartment code 104



Continued overleaf

**DESCRIPTION OF THE TELEPHONE**

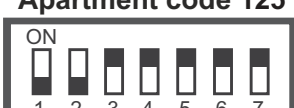
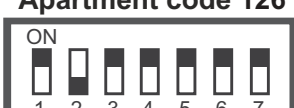
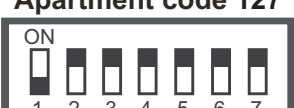
Continued from previous page.

<p><b>Apartment code 105</b></p> 	<p><b>Apartment code 106</b></p> 	<p><b>Apartment code 107</b></p> 	<p><b>Apartment code 108</b></p> 
<p><b>Apartment code 109</b></p> 	<p><b>Apartment code 110</b></p> 	<p><b>Apartment code 111</b></p> 	<p><b>Apartment code 112</b></p> 
<p><b>Apartment code 113</b></p> 	<p><b>Apartment code 114</b></p> 	<p><b>Apartment code 115</b></p> 	<p><b>Apartment code 116</b></p> 
<p><b>Apartment code 117</b></p> 	<p><b>Apartment code 118</b></p> 	<p><b>Apartment code 119</b></p> 	<p><b>Apartment code 120</b></p> 
<p><b>Apartment code 121</b></p> 	<p><b>Apartment code 122</b></p> 	<p><b>Apartment code 123</b></p> 	<p><b>Apartment code 124</b></p> 
<p><b>Apartment code 125</b></p> 	<p><b>Apartment code 126</b></p> 	<p><b>Apartment code 127</b></p> 	<p><b>Apartment code 128</b></p> 

**'Doctor mode' function:**

**Description:**

The 'doctor mode' function enables lock release 1 to be activated automatically 3 seconds after making a call from the door panel without having to establish communication or press door release button . The call ends after 7 seconds and the channel is free. **(Only the master telephone should be configured with 'doctor mode').**

**Configuring 'doctor mode':**

To configure 'doctor mode' on the (master) telephone, access the DIP switch inside the telephone and set DIP 12 to ON.

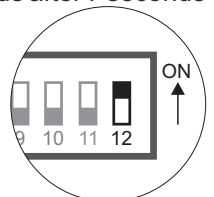

**Activating/deactivating 'doctor mode':**

To activate 'doctor mode', the telephone must be in standby mode:  
Turn the volume control switch to OFF.

To deactivate 'doctor mode', the telephone must be in standby mode:  
Set the OFF position of the volume control switch to a medium or maximum position depending on the required call volume.

**Intercom function:**

Intercom functionality between two points in the same apartment comes as standard with the T562 GB2 telephone.

The telephone must be in standby to make intercom calls.

To make an intercom call, pick up the handset and press intercom button **AUX**, a number of tones on the telephone(s) being called in the apartment will confirm that the call is being made.

The call needs to be answered within 40 seconds.

To establish communication, pick up the handset of the telephone called (or one of the telephones called if there is more than one slave telephone).

Communication will last for one and a half minutes or until the handset is hung up.

**Light activation function:**

The telephone must be in standby with the handset hung up for light activation (SAR-GB2 and SAR-12/24 modules required).

For light activation (e.g. 'staircase light'), press button **AUX**.

**Important:** For connections and configuration, see the TSAR-GB2 and TSAR-12/24 manuals.



## DESCRIPTION OF THE TELEPHONE

### Setting the ringtones:

#### Description:

The telephone's ringtones (door panel, intercom and apartment door) can be changed by using the configuration button located in the top left part of the inside of the telephone.

There are three ringtone selection groups and each consists of three fixed tones. The first tone of each group heard during selection corresponds to door panel calls, the second to intercom calls and the third to apartment door calls.

#### Setting and selecting the ringtone group:

The telephone must be in standby to configure and select the required ringtone group.

To change the ringtones, open the telephone (see p. 10) and press the hook switch.

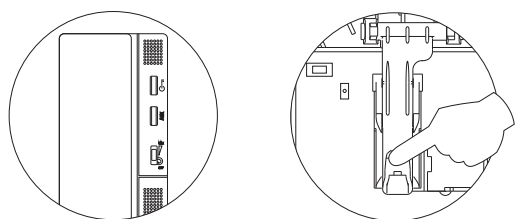

With the hook switch held down, press the configuration button; the handset will emit the configured ringtone group.

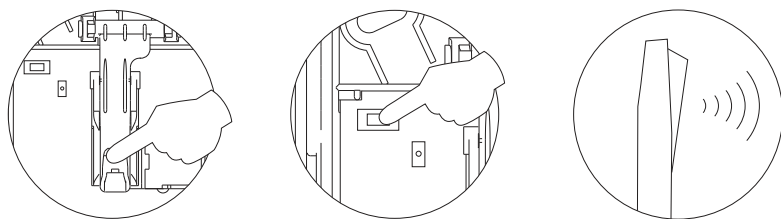

To change the ringtone group, press the configuration button until the required ringtone group can be heard (up to 3 ringtone groups available in carousel mode).

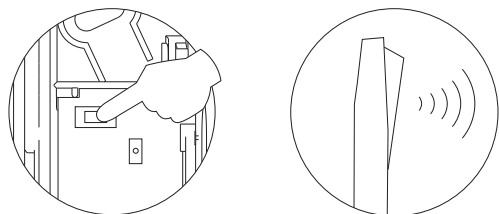

To save the selection, release the hook switch. Then close the handset and hang it up.

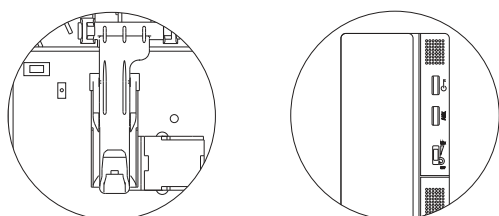

Make a call to check that the correct ringtone group for the telephone has been selected.



## INSTALLING THE TELEPHONE

### ***Fixing the telephone to the wall:***

Avoid dusty or smoky environments or locations near sources of heat. The telephone can be fixed to an electrical embedding box or directly to the wall.

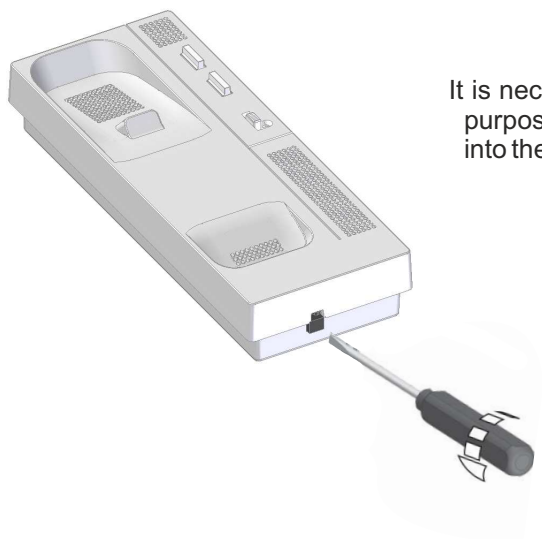

It is necessary to open the telephone for wiring and fixing purposes. To open the telephone, insert a flat screwdriver into the slots and gently pry open as shown in the drawing.

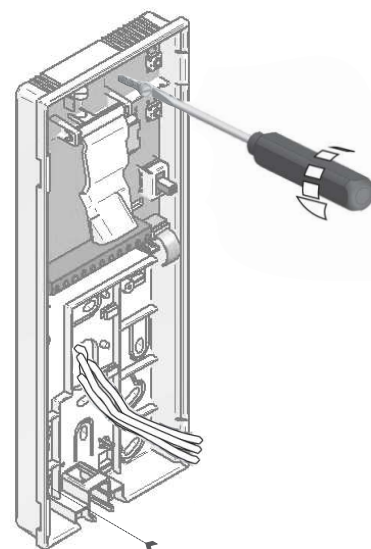

The telephone can be fixed to a universal embedding box or directly to the wall. To fix directly to the wall, drill two 6mm holes at the specified positions and use 6mm wall plugs and  $\text{Ø}3.5 \times 25\text{mm}$  screws.

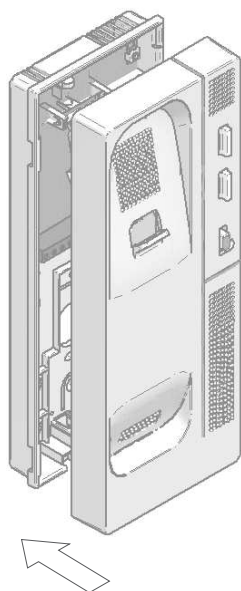

Pass the cables through the cable holes and connect them to the connector as per the wiring diagram. Close the telephone as shown in the drawing. Once the telephone is closed, connect the handset using the telephone cord and place it on the hook.

WIRING DIAGRAMS

**Installation with 32 apartments/T562 GB2 telephones and Golmar DC lock release:**

**(\*) IMPORTANT:**

With a coded panel system:

- EL632 GB2A/EL642 GB2A sound module is required and must be set to 'operating mode 5'.

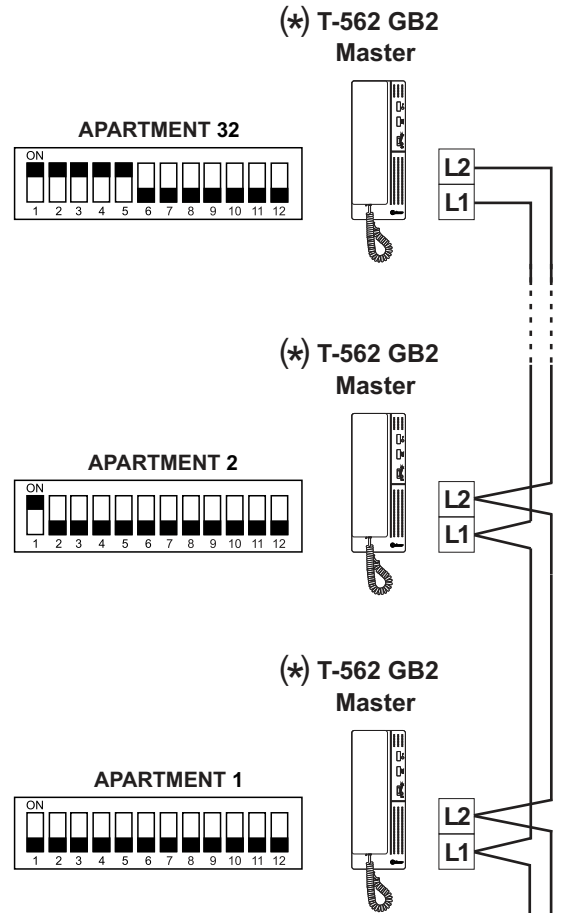

**Distances and cross-sections:**

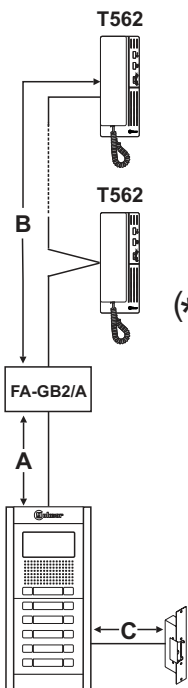

Cable	A	B	C
Twisted pair 2x0.75mm <sup>2</sup>	60m	60m	10m
Twisted pair 2x1mm <sup>2</sup>	80m	80m	15m

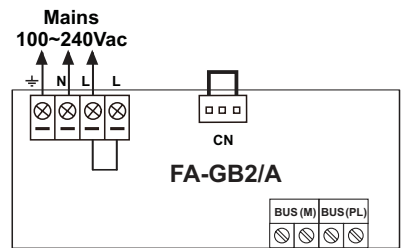

**(\*) IMPORTANT:** Set the DIP switches as shown in the diagram.

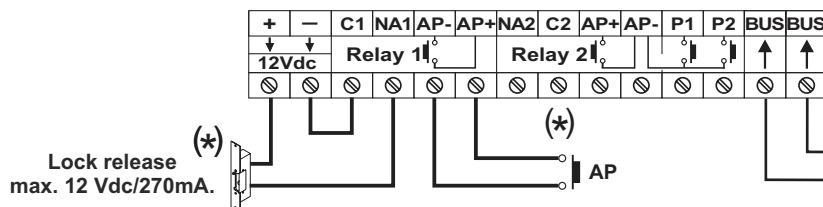
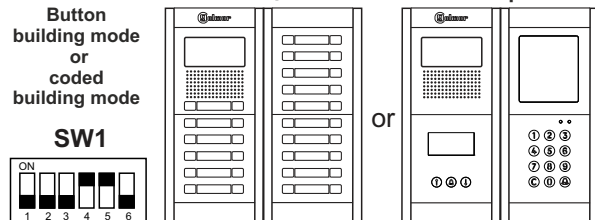

(\*) For more information about the door panel, installation, configuration, connection of an AC lock release, 2nd lock release or mixed installation with monitors and audio terminals, see the corresponding door panel manual.

WIRING DIAGRAMS

**Audio door entry system with 128 apartments/T562 GB2 telephones and Golmar DC lock release:**

**IMPORTANT:**

- (\*) - Up to 128 apartments/telephones per installation 'audio only':  
**EL632 GB2A/EL642 GB2A** sound module required and button panel must be set to 'operating mode 2' or coded panel to 'operating mode 6'.
- (1) - The T562 telephone's DIP 10 should be set to ON.

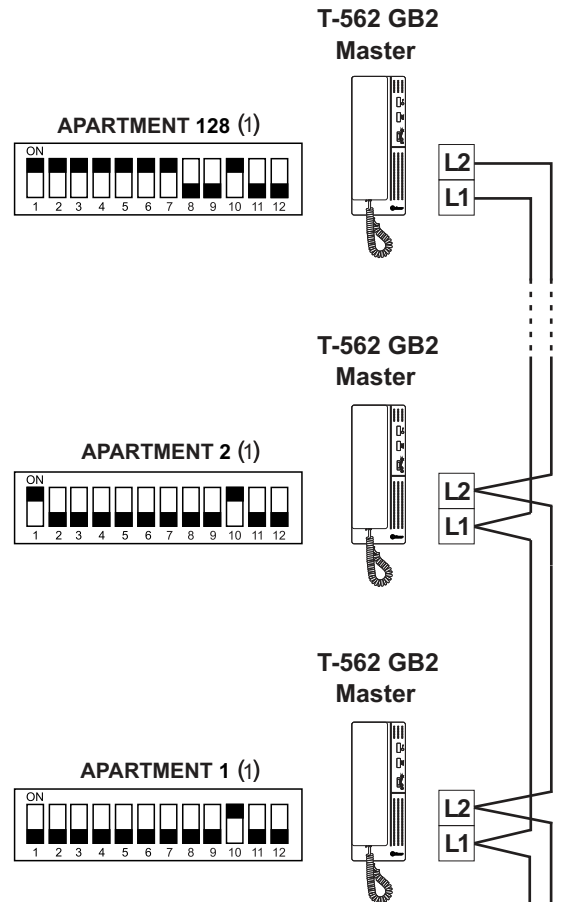

**Distances and cross-sections:**

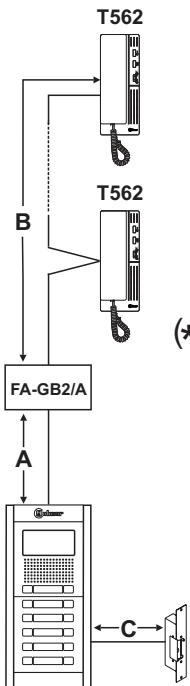

Cable	A	B	C
Twisted pair 2x0.75mm <sup>2</sup>	60m	60m	10m
Twisted pair 2x1mm <sup>2</sup>	80m	80m	15m

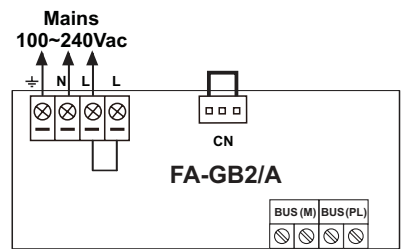

(\*) **IMPORTANT:** Set the DIP switches as shown in the diagram.

Telephone only button mode or telephone only coded mode

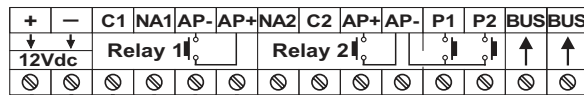
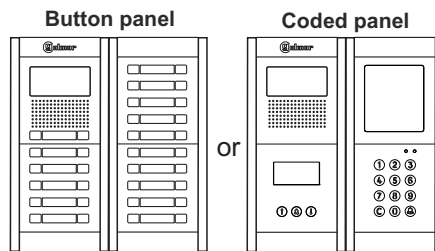

Lock release (\*) max. 12 Vdc/270mA.

(\*) For more information about the door panel, installation, configuration, connection of an AC lock release, 2nd lock release or mixed installation with monitors and audio terminals, see the corresponding door panel manual.