



T300EN

rev.0204

Audio and Video  
door entry system  
digital installation

295 Series

Instructions manual

First of all we would like to thank and congratulate you for the purchase of this product manufactured by Golmar.

The commitment to reach the satisfaction of our customers is stated through the ISO-9001 certification and for the manufacturing of products like this one.

Its advanced technology and exacting quality control will do that customers and users enjoy with the legion of features this system offers. To obtain the maximum profit of these features and a properly wired installation, we kindly recommend you to expend a few minutes of your time to read this manual.

## INDEX

Introduction .....	1	T-940 Plus telephone .....	
Index .....	1	Description .....	16
Starting recommendations .....	1	Function push button .....	16
System characteristics .....	2	Telephone installation .....	17
System operation .....	2	Programming .....	18
Door panel installation .....		Installation diagrams .....	
Embedding box positioning .....	3 to 4	Connection of an a.c. lock release .....	19
Door panel fixing .....	4	Link of several power supplies .....	19
Door panel wiring .....	4 to 5	Video installation with coaxial .....	20 to 21
Push buttons coding .....	5	Video installation without coaxial .....	22 to 23
Door panel settings .....	6 to 7	Audio installation .....	24 to 25
EL560 optional module .....	7	Optional connections .....	
Final adjustments .....	8	External lock release activation .....	26
Power supply installation .....	9	Auxiliary devices activation .....	26
Lock release installation .....	9	Intercom function .....	27
Platea Plus monitor .....		TV connection .....	27
Description .....	10	2nd camera activation .....	28
Function push buttons .....	11	Door bell push button connection .....	28
EL561 module .....	12	Troubleshooting hints .....	29
End of line resistor .....	12		
Front film replacement .....	12		
Monitor connector description .....	13		
Monitor installation .....	14		
Programming .....	15		

## STARTING RECOMMENDATIONS

- ☞ Do not use excessive force when tightening the power supply connector screws.
- ☞ Install the equipment without the power connected. Disconnect from power before any system modification. Check that the input voltage is lower than 230Va.c.
- ☞ Before to connect the system, check the connections between door panel, monitors and telephones, and the transformer connection. Do always follow the enclosed information.
- ☞ Each time the power supply is restarted, or after a modification, the system will remain blocked during 30 seconds.
- ☞ Always use RG-59 or RG-11 coaxial cables. Never use coaxial antenna cable. In installations no longer than 100m., Golmar RAP-5130 cable can be used.

- ⇨ Microprocessed system with 3 common wires plus coaxial cable installation or 4 common wires plus twisted pair (only for kits /SC).
- ⇨ Fully compatible with 'Stadio' audio systems of 4 common wires installation.
- ⇨ Unlimited number of door panels being not necessary the use of switching units.
- ⇨ Acoustic busy channel and call acknowledgement signals.
- ⇨ d.c. lock releases activation.
- ⇨ Timed door open activation.
- ⇨ In Platea Plus monitors or T-940 Plus telephones:
  - ☞ Privacy on audio and video communications.
  - ☞ 'Video-Spy' function remaining the communication channel free.
  - ☞ Intercommunication function with other monitor or telephone of the same apartment.
  - ☞ Input for door bell apartment push button.
  - ☞ Different call reception tones depending where the call is coming from: main or slave door panels, door bell push button, intercom, ...
  - ☞ Activation of two auxiliary devices: secondary telecamera, courtesy light, ...
  - ☞ Up to three monitors or telephones in the same apartment without additional power supplies.

# SYSTEM OPERATION

- ⇨ To make a call the visitor should press the push button corresponding to the apartment he wishes to contact. An acoustic tone will be heard confirming the call is in progress once the push button has been pressed. At this moment the call will be received at the monitor (telephone) in the dwelling. During the call the visitor can correct his call by pressing a push button corresponding to a different apartment, in which case the original call is cancelled.
- ⇨ In systems with several access doors, the other(s) door panel(s) will be automatically disconnected: if a visitor tries to call from other door panel an acoustic tone will be heard confirming the system is busy.
- ⇨ The call tone will be reproduced on the monitor during 3 seconds: after this time the picture will appear on the master monitor without the visitor being aware of this. To see the picture in a slave monitor press the ⊕ push button, disappearing the picture on the other monitor. If the call is not answered in 45 seconds, the system will be freed.
- ⇨ To establish communication pick up the monitor (telephone) handset. The communication will last for one and a half minutes or until the handset is replaced. Once the communication has finished the system will be freed.
- ⇨ To open the door, press the door release push button during call or communication progresses: with one press, the door release operates during 3 seconds. During the lock release activation an acoustic tone will be heard on the door panel confirming the lock release is activated.
- ⇨ The monitor and telephone push buttons description is shown on pages 11 and 16 respectively.

## Embedding box positioning.

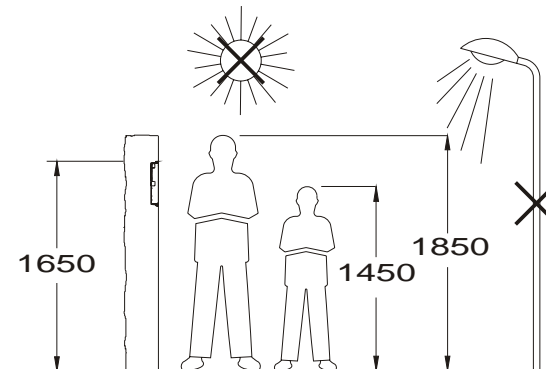

The upper part of the door panel should be placed at 1,65m. height roughly. The hole dimensions will depend on the number of door panel modules.

Modules	1	2	3
W	140	280	420 mm.
H	235	235	235 mm.
D	57	57	57 mm.

The door panel has been designed to be placed under most of the environmental conditions. However it's recommended to take additional cautions like rainproof covers. To obtain a good quality picture on video door entry systems, avoid direct incidence from light sources.

## Preparing the cables entry.

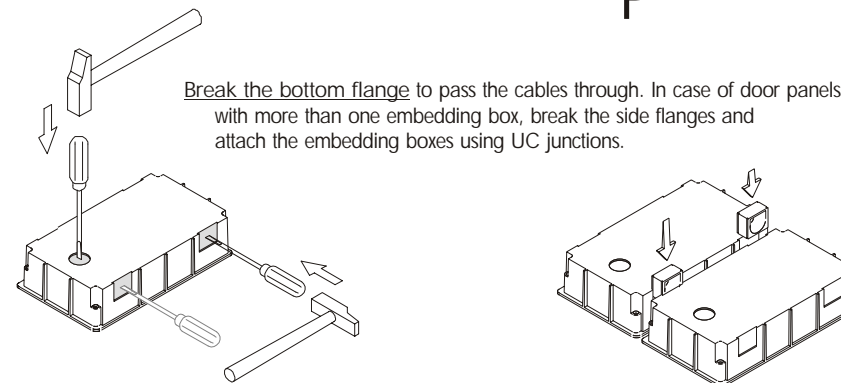

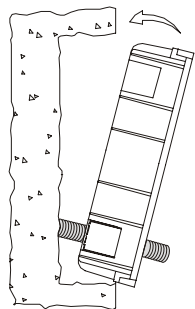

**P**lace the embedding box.

Pass the wiring through the hole made in the bottom part of the embedding box. Level and flush the embedding box. Once the embedding box is placed, remove the protective labels from the attaching door panel holes.

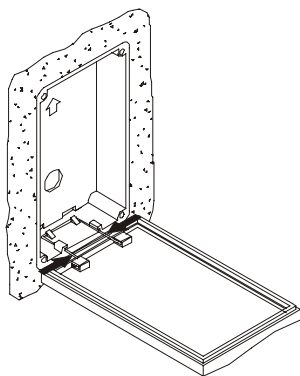

**H**old the door panel on the embedding box.

Insert the hinge in the embedding box lockers. Press the hinge ends to insert them in the door panel lockers as shown.

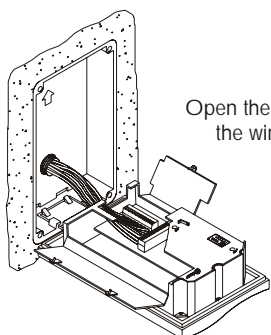

Open the terminal connector cover and connect the wires as shown on the installation diagram.

**D**oor panel wiring.

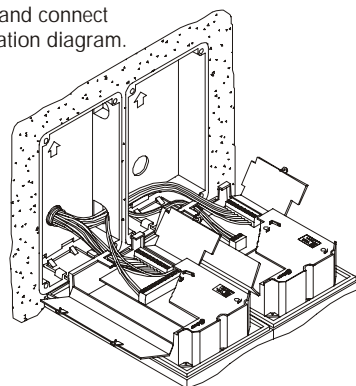

In case of door panels with more than one module link the main module with the push buttons modules through the UC junctions and wire them as shown on the following page.

**L**inking the push buttons modules.

The maximum number of push buttons modules contained in a door panel is two, obtaining a maximum of 24 push buttons. Wire the push buttons modules with the main module as shown below.

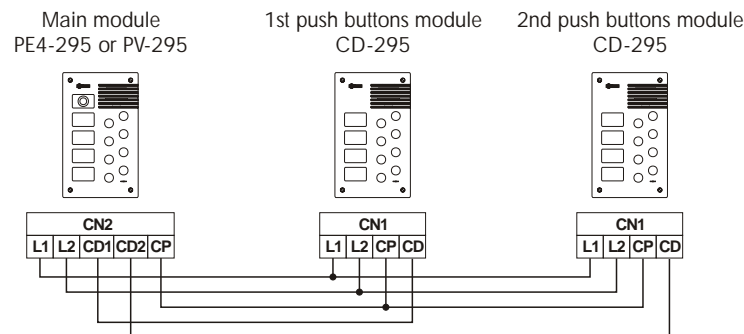

**P**ush buttons digital code.

Each push button has a digital code assigned in it, that will be recorded on the corresponding monitor (telephone) during the recording progress. In case to combine these door panels with "Stadio Plus" door panels or with PV-295/CODE or PE4-295/CODE general entrance door panels, it will be necessary to know these codes for a properly system configuration.

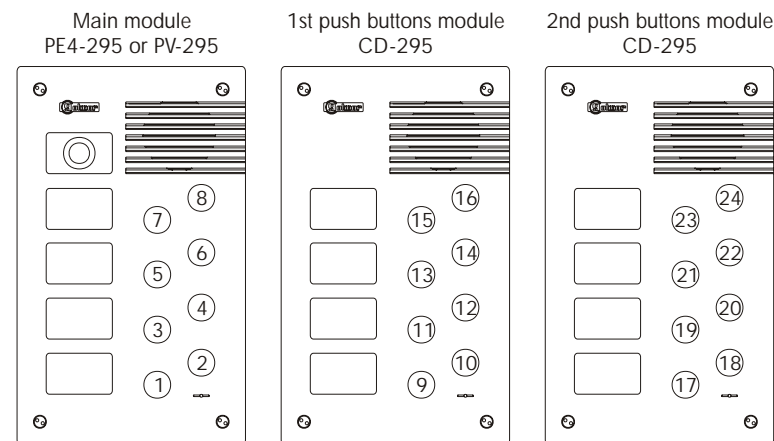

## Description of the configuration jumpers.

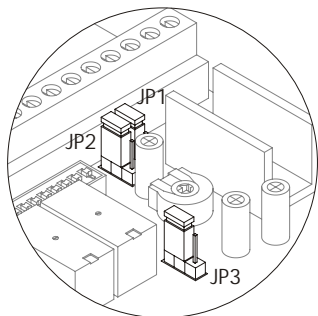

The JP1 and JP2 configuration jumpers are placed near of the configuration dip switch, and are accessible by opening the terminal connector protection cover. The JP3 jumper is accessible by extracting the pcb protection cover.

Jumper JP1 allows the activation of a heater resistor, that prevents from telecamera window condensations when the panel is installed in humid areas. Check the availability of this heater resistor. Factory default: disabled.

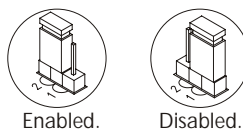

Jumper JP2 loads the installation with a communications resistor. For a proper system operation, activate this resistor only in the closest door panel to the backbone installation or in the general entrance door panel (if exists). Factory default: enabled.

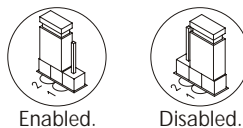

Jumper JP3 selects the volume of the door panel acknowledgement signals (call in progress, system busy and door opened). If after starting the system it's considered that the volume is too high, modify the jumper position. Factory default: maximum.

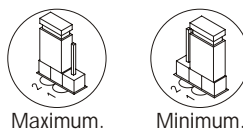

## Description of the configuration dip switch.

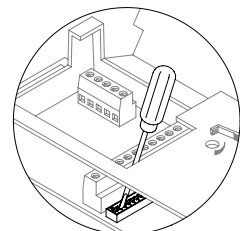

The configuration dip switch is accessible by opening the terminal connector protection cover.

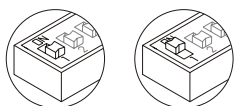

Switch number 1 allows to activate the autoswitch-on function (audio and video communication without previous call) at the door panel that has this switch to ON position. In systems with several door panels activate this function only in one of them; in systems with general entrance panel this function can be activated in one door panel of each internal building.

Continue

Coming from previous page

## Description of the configuration dip switch.

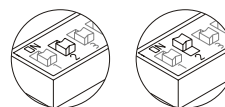

Set to ON the switch number 2 for monitor or telephones programming. Once the programming progress is finished return the switch to OFF position. The programming process is described on pages 15 (monitors) and 18 (telephones).

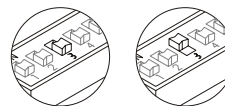

Set to OFF the switch number 3 in case of a master door panel. Each system must have only one master door panel; the rest must be slaves (ON). In systems with general entrance panel set as master one door panel of each internal building.

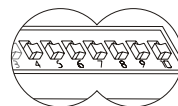

Switches number 4 to 10 set the building code. In systems with several door panels, set the same code in all the panels; in systems with general entrance panel, set different codes for each internal building. Valid codes are from 0 (factory default) to 99. To set the code use binary coding as shown on the next paragraph.

## Binary coding of the configuration dip switch.

The switches set to OFF have null value. The values of the switches set to ON are shown in the enclosed chart. The building code will be calculated as the sum result of the switches values set to ON.

Switch number:	4	5	6	7	8	9	10
ON value:	64	32	16	8	4	2	1

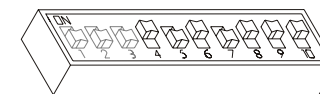

Example:  $64 + 0 + 16 + 0 + 4 + 2 + 1 = 87$

## Optional. EL560 module for video installations with twisted pair cable.

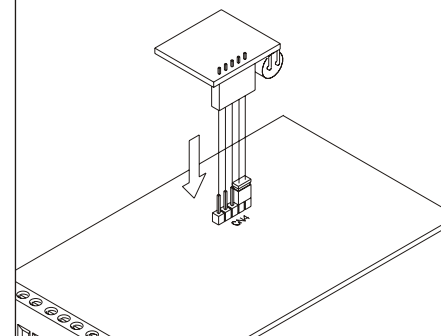

Plug the EL560 module in the CN4 connector. The CN4 connector is accessible by unbolting the five screws of the pcb cover protection. Once the connector has been located, remove the existing jumper and plug the module in. NOTE: on this type of installations the EL561 module must be plugged in all the monitors. Refer to the specific installation diagram.

**P**lace the nameplate labels.

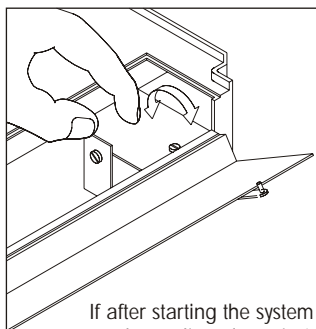
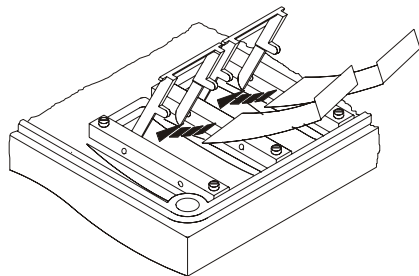

If after starting the system it's considered that the audio volume isn't correct, proceed with the necessary adjustments as shown. Use the included pan mechanism to adjust the telecamera position.

**F**inal adjustments.

Monitor Telephone  
Door panel

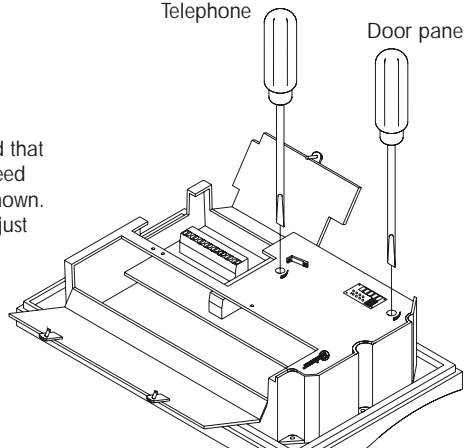

**C**lose the door panel.

Fix the door panel to the embedding box by using the supplied vandal resistant screws and the special screwdriver.

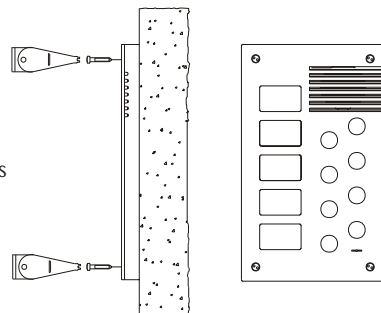

**I**nstalling the FA-PLUS and FA-PLUS/C power supplies.

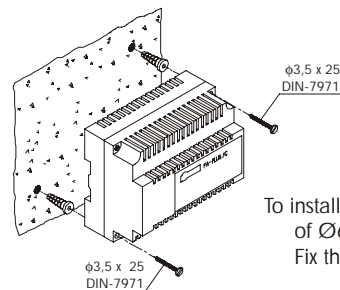

The power supply must be installed in a dry and protected place. It's recommended to protect the power supply by using a thermo-magnetic circuit breaker and to use a ground connection.

To install the power supply directly on the wall, drill two holes of Ø6mm. and insert the wallplugs. Fix the transformer with the specified screws.

The power supply can be installed on a DIN 46277 guide simply pressing it. To disassemble the power supply from the DIN guide, use a plain screwdriver to lever the flange as shown on the picture.

The FA-Plus/C model uses 6 units over DIN guide and 10 units the FA-Plus model.

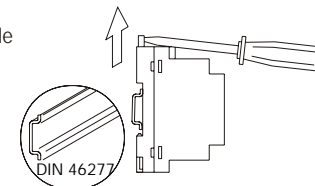

**IMPORTANT:** the maximum number of units that can be connected to a FA-Plus/C power supply is 10, and 50 units in case of a FA-Plus model. Link power supplies to connect more units than the specified as it's shown on page 19.

**L**ock release installation.



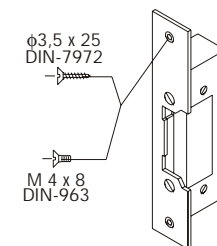

If the lock release will be installed in a metal door, use a Ø3,5mm. drill and tap the hole. In case of wood door, use a Ø3mm. drill.

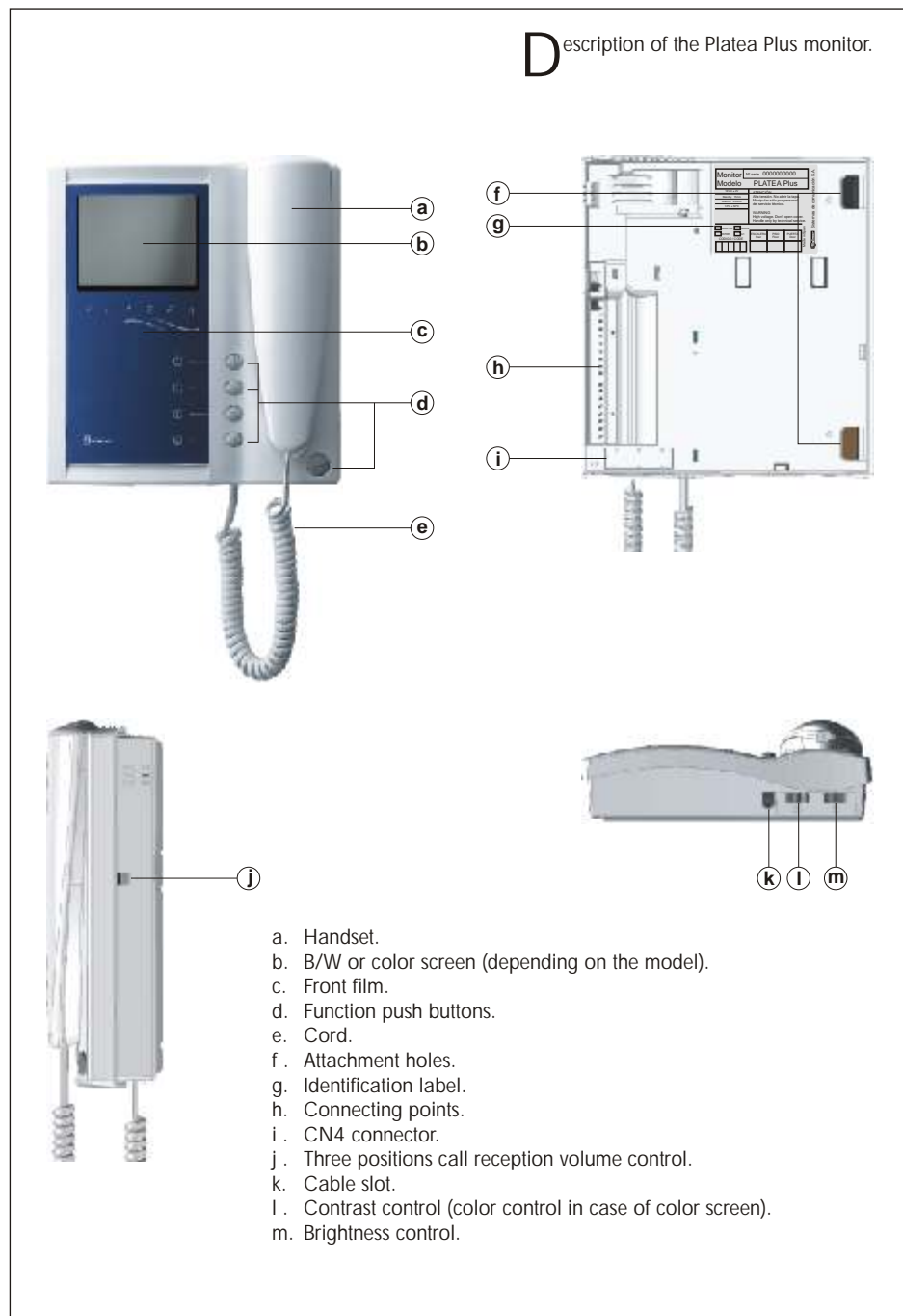

**IMPORTANT:** the lock release to be used must be of 12Vd.c. If you are using a.c. lock releases, use one R-3 relay unit and one TF-104 transformer to activate it, as it is shown on page 19.



**F**unction push buttons.

-  On-Off push button. After any monitor reset and during the next 45 seconds, all the monitor functions will be disabled, with the exception of call reception.
-  If the handset is on the cradle allows the activation of an optional second camera (\*). If not, allows to make an intercom call or to activate the second camera (\*).
-  If the handset is on the cradle allows the activation of an optional device. If not, allows to call to a slave porter's exchange (\*) or to activate the optional device.
-  If the handset is on the cradle allows to see the picture from the master door panel. If not, allows to establish audio and video communication with the door panel that has been configured with the autoswitch-on function. This function is disabled if a communication is already established.
-  If the handset is on the cradle sends a panic call to the porter's exchanges that have enabled the reception of this type of call. If not, allows to call to the master porter's exchange. During call reception and communication progresses allows the lock release activation.

(\*) Second camera activation and call to a slave porter's exchange functions require an internal modification of the monitor. If any of these functions are required, contact with your nearest authorized distributor.  
 Second camera activation disables the intercomm function and call function to a slave porter's exchange disables optional device function.

**D**escription of the identification label.

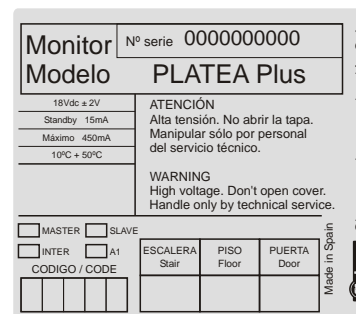

For an easiest repair, replacement or increase of the existing monitors, fill the identifying label information.

- MASTER: master monitor.
- SLAVE: slave monitor.
- INTER: slave monitor with intercom function.
- A1: monitor connected to an auxiliary device.
- CODE: push button code (see page 5).
- STAIR: building code (see page 7).

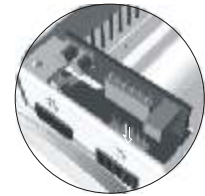

**E**L561 module for video installations with twisted pair cable.

Locate the CN4 connector, that's placed in the monitor base. Remove the existing jumper and plug the EL561 module.

NOTE: on this type of installations the EL560 module must be plugged in the CN4 connector of the panel (page 7). Refer to the specific installation diagram.

**H**andling the end of line jumper.



The end of line jumper is placed on the CN4 connector, that can be located on the monitor base. In case of twisted pair cable installations, the end of line jumper is placed in the EL561 module, also located in the CN4 connector of the monitor base.

Do not remove the jumper on monitors where the video cable finish. Remove the jumper on monitors where the video cable continue.

**C**hanging the front film.

The monitor is supplied with a reversible front film, that allow the owner to choose between two colors. To change the front film, remove the front plate by inserting a plain screwdriver in the triangle marks, as it is shown on the drawing.



**D**escription of the RCPL-Plus monitor connector.

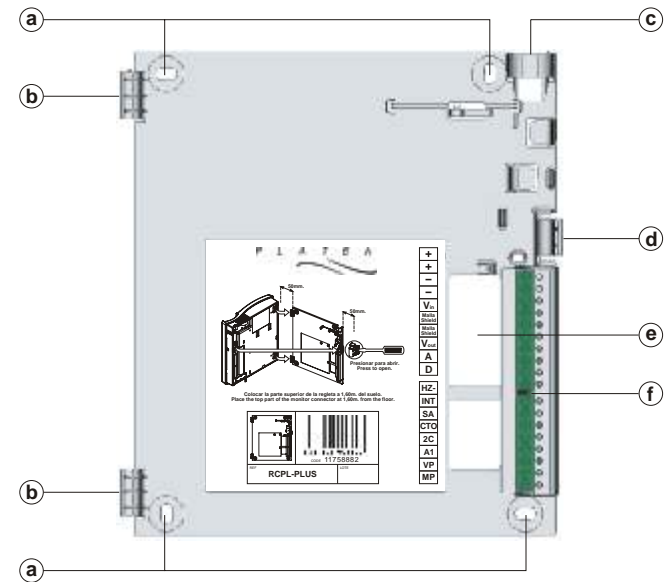

- a. Wall attachment hole (x4).
- b. Monitor attachment hook (x2).
- c. Vertical wiring input.
- d. Attachment clip.
- e. Wiring input hole.
- f. Installation terminals:

- + , - : positive, ground.
- Vin : video signal coaxial input.
- Malla : coaxial shield.
- Vout : video signal coaxial output.
- A : audio communication.
- D : digital communication.
- HZ- : door bell push button input.
- INT : intercom.
- SA : auxiliary calling device output.
- CTO : video distributor activation output.
- 2C : 2nd camera activation output.
- A1 : optional device activation output.
- Vp, Mp : twisted pair video signal.

Terminals +, - and Malla (shield) are duplicated for easiest cascade installation of parallel monitors or telephones. If the first monitor is not placed on the connector, cascade units will not be powered.



**F**ix the monitor connector to the wall.

Avoid to place the monitor near to heating sources, in dusty locations or smoky environments. To install the monitor directly over the wall, drill two holes of Ø6mm. and use the supplied screws.

The upper part of the monitor connector must be placed at 1,60m. height roughly. The minimum distance between the monitor connector and the closest object must be 5cm.



**F**ix the monitor.

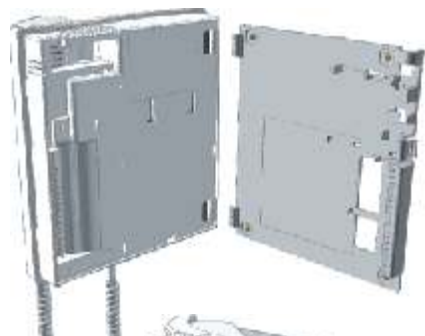

Place the monitor at right angles to the connector and align the attaching holes of the monitor with the attachment hooks of the connector, as it is shown on the drawing.



Lock out the monitor. Press the right side till the attachment clip locks the monitor firmly.

To disassemble the monitor from the connector, use a plain screwdriver to release the attachment clip. Remove the monitor from the connector, with special attention do not falls.



**P**rogramming the monitors.

Set to ON the switch number 2 of the configuration dip switch, that's accessible by opening the terminal connector protection cover. The door panel will reproduce a sound to advise that the system has entered into programming mode.

In systems with more than one door panel, the programming process shall be done on the master door panel only.

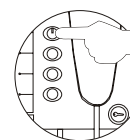
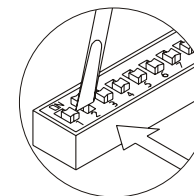

Switch off the monitor to be programmed.

Once the monitor is off, press the door release push button.

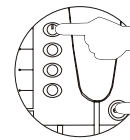
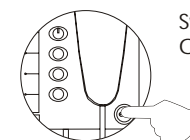

With the door release push button pressed switch on the monitor.

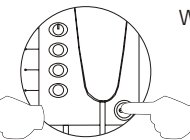

To show that the system is ready for programming, the door panel will reproduce a sound and the picture will appears on the monitor. At this moment, the door release push button can be released. Lift the handset to establish audio communication with the door panel.

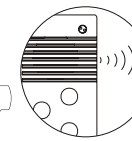
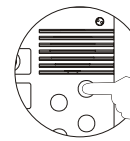

Press the door panel push button that will call to this monitor. At this moment the door panel will reproduce a sound and the monitor led will blink.

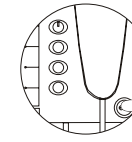
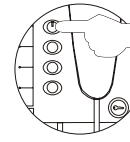
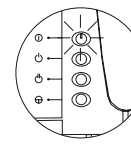

To program the monitor as master, switch it off and on again.

To program it as slave, press the door release push button.

To program it as slave with intercom function press the  push button.

Each apartment must have one master unit only; in case of parallel units configure them as slaves, both monitors or telephones.

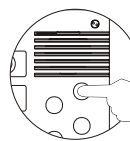

Make a call to check that the monitor has been succesfully programmed.

Repeat these steps to program the rest of monitors.

Once the programming has been finished, set to OFF the programming switch. If you don't, the door panel will reproduce a sound to advise that the system is still into programming mode.

**D**escription of the T-940 Plus telephone.



- a. Telephone handset.
- b. Speaker grille.
- c. Microphone hole.
- d. Subjection hole.
- e. Telephone cord connectors.
- f. Function push buttons.
- g. On-Off light indicator.
- h. Call reception volume control.
- i. Hook switch.



The telephone has a three positions switch placed on the bottom part of the telephone (closest to the telephone cord connector) that allows to control the call reception level volume.

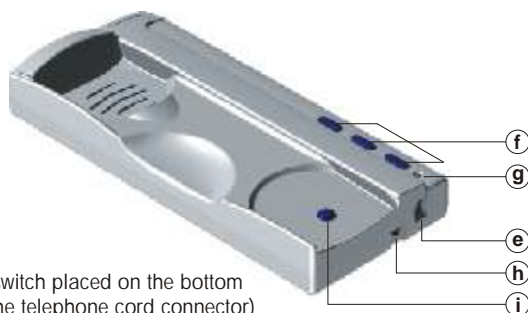

**F**unction push buttons.

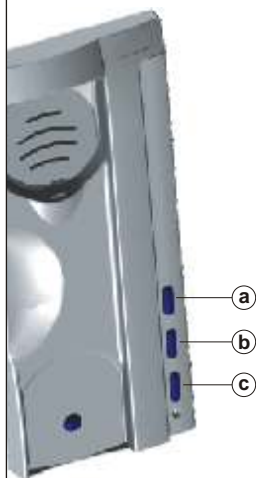

- a. On-Off push button.  
After any telephone reset, and during the next 45 seconds, all the telephone functions will be disabled, with the exception of call reception.
- b. This push button allows to make an intercom call when the handset is not on the cradle. This function is described on page 27.
- c. If the handset is on the cradle sends a panic call to the porter's exchanges that have enabled the reception of this type of call. If not, allows to call to the master porter's exchange. During call reception and communication progresses allows the lock release activation.

**T**erminal connector description.



- + , - : positive, ground.
- A , D : audio, digital communication.
- INT : intercom.
- SA : auxiliary calling device output.
- HZ- : door bell push button input.

TELEPHONE INSTALLATION

**F**ix the telephone.

It will be necessary to open the telephone for wiring and fixing purposes. To open the telephone insert a plain screwdriver into the slots and rotate it as shown.

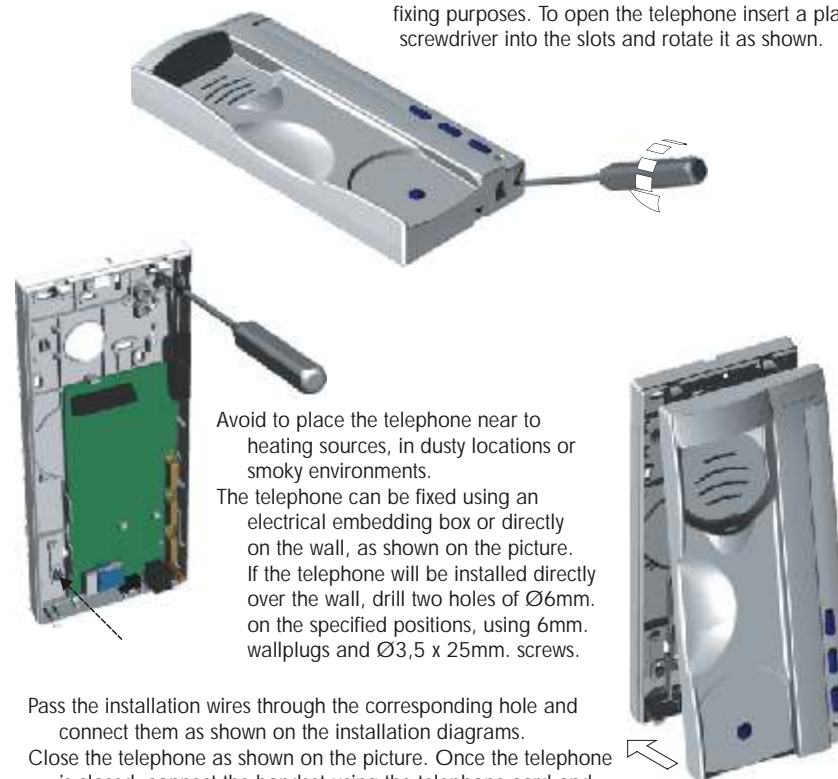

Avoid to place the telephone near to heating sources, in dusty locations or smoky environments.

The telephone can be fixed using an electrical embedding box or directly on the wall, as shown on the picture. If the telephone will be installed directly over the wall, drill two holes of Ø6mm. on the specified positions, using 6mm. wallplugs and Ø3,5 x 25mm. screws.

Pass the installation wires through the corresponding hole and connect them as shown on the installation diagrams. Close the telephone as shown on the picture. Once the telephone is closed, connect the handset using the telephone cord and put it on the cradle.

**P**rogramming the telephones.

Set to ON the switch number 2 of the configuration dip switch, that's accessible by opening the terminal connector protection cover. The door panel will reproduce a sound to advise that the system has entered into programming mode.

In systems with more than one door panel, the programming process shall be done on the master door panel only.

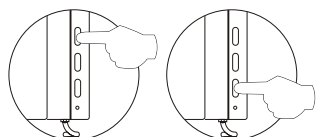
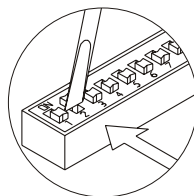

Switch off the telephone to be programmed. Once the telephone is off, press the door release push button.

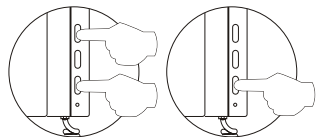

With the door release push button pressed switch on the telephone.

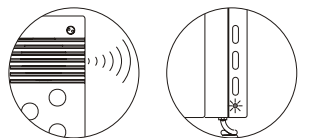

To show that the system is ready for programming, the door panel will reproduce a sound and the telephone led will blink. At this moment, the door release push button can be released. Lift the handset to establish audio communication with the door panel.

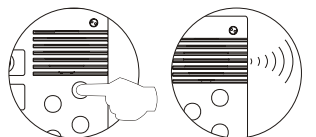

Press the door panel push button that will call to this telephone. At this moment the door panel will reproduce a sound and the telephone led will blink.

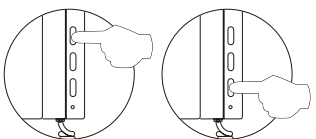

To program the telephone as master, switch it off and on again. To program it as slave, press the door release push button. To program it as slave with intercom function press the center push button.

Each apartment must have one master unit only; in case of parallel units configure them as slaves, both monitors or telephones.

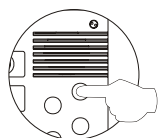

Make a call to check that the telephone has been successfully programmed. Repeat these steps to program the rest of telephones. Once the programming has been finished, set to OFF the programming switch. If you don't, the door panel will reproduce a sound to advise that the system is still into programming mode.

**C**onnexion of an a.c. lock release.

As it is described on page 9, the lock releases to be connected to the door panel must be d.c. type. If an a.c. lock release has been installed before, use a R-3 relay unit and a TF-104 transformer, and connect them to the lock release as it is shown on the enclosed diagram.

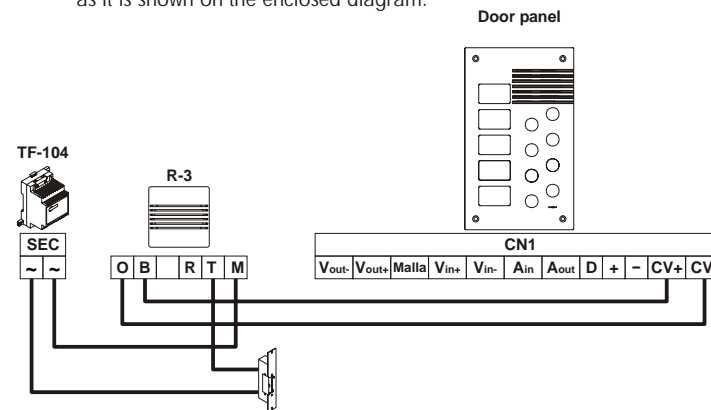

**L**ink of several power supplies units.

If the quantity of monitors or telephones to be connected is bigger than the supported from one power supply (see page 9), use additional power supplies to match the required quantity. The first power supply should be connected to the door panel and to the first group of monitors or telephones; connect the next groups to the positive terminal of its corresponding power supply.

To wire several power supplies link their ground terminals; **NEVER** link positive terminals of different power supplies.

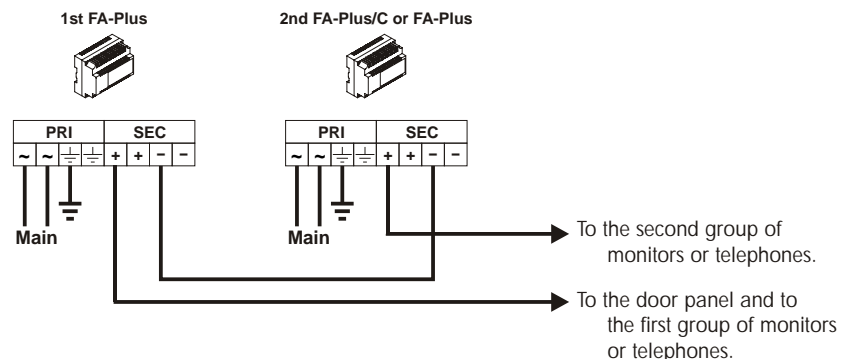

\* Take off JP1 jumper of all the distributors except in the last one.

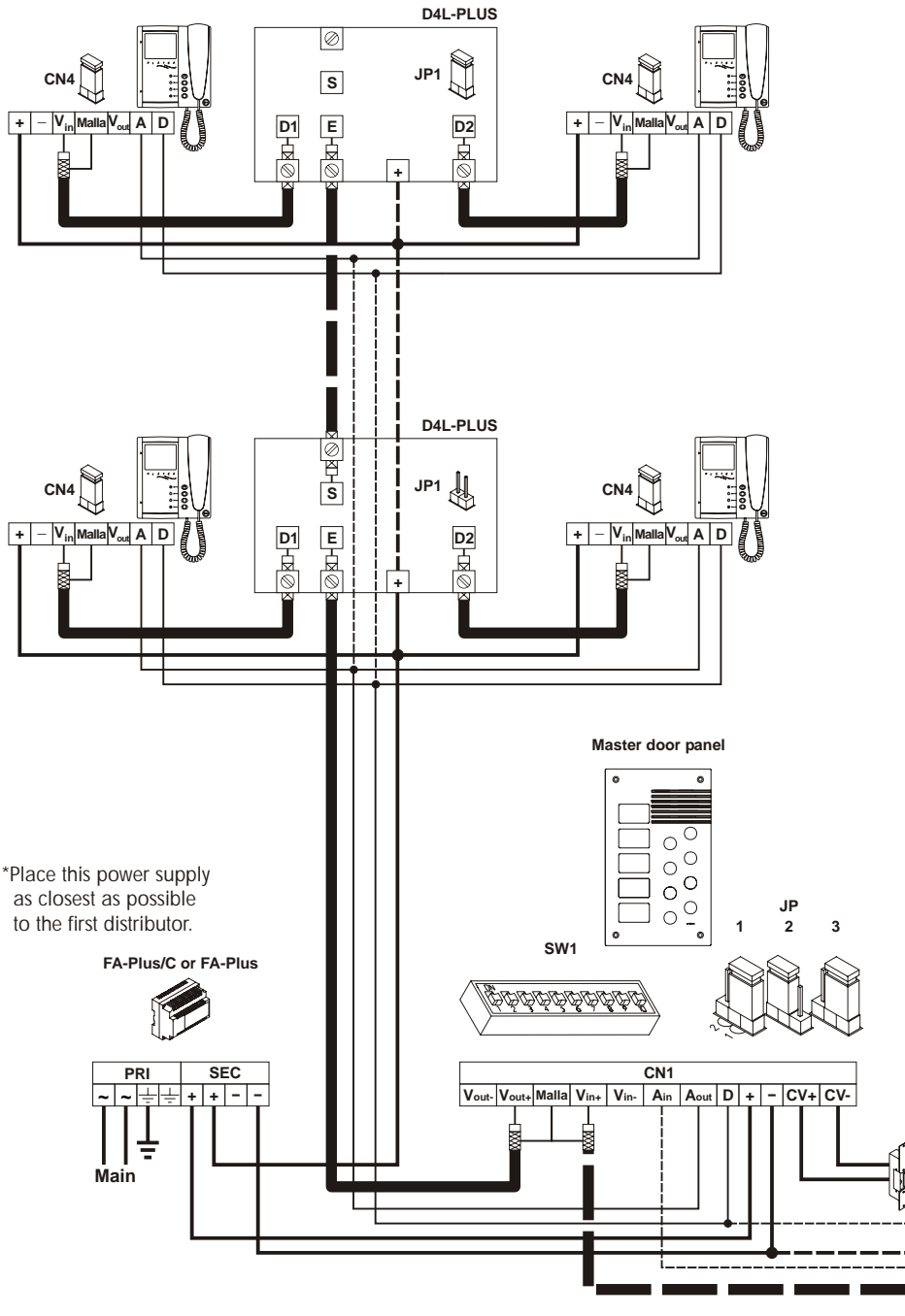

\*Place this power supply as closest as possible to the first distributor.

## V Video installation with coaxial cable.

The installation diagram shows the connection of a video system with one or several door panels for the same building. If the system has one door panel only, override the wiring to the second door panel. If the system has more than one door panel, wire the second panel as shown on the diagram. In case of more than two door panels, wire them as the second is connected.

SECTIONS CHART	Distance	
	50m.	150m.
Terminal	50m.	150m.
+, -, CV+, CV-	1,00mm <sup>2</sup>	2,50mm <sup>2</sup>
A <sub>in</sub> , A <sub>out</sub> , A, D	0,25mm <sup>2</sup>	0,25mm <sup>2</sup>
V <sub>in</sub> +, V <sub>out</sub> +, V <sub>in</sub> -, V <sub>out</sub> -	RG-59	RG-59

For longer distances than the specified contact with your distributor.

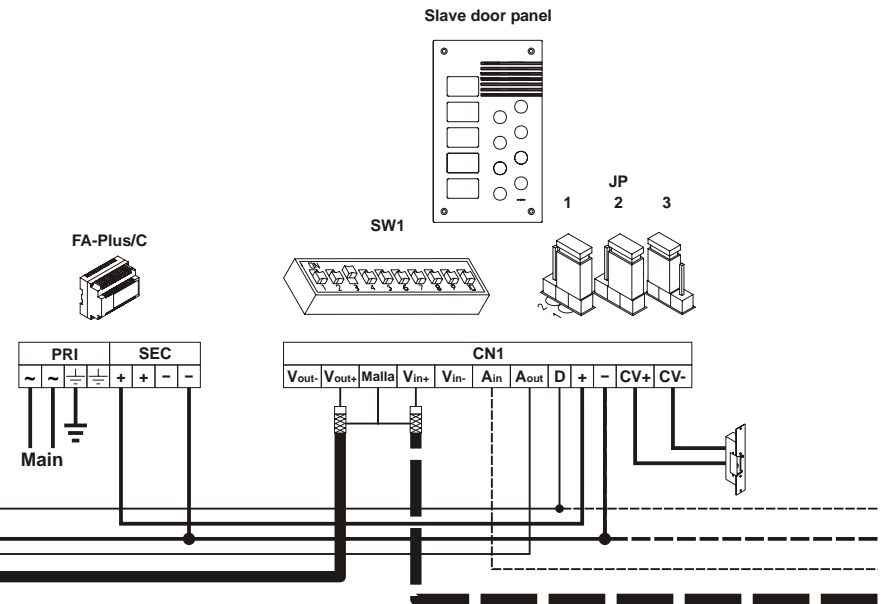

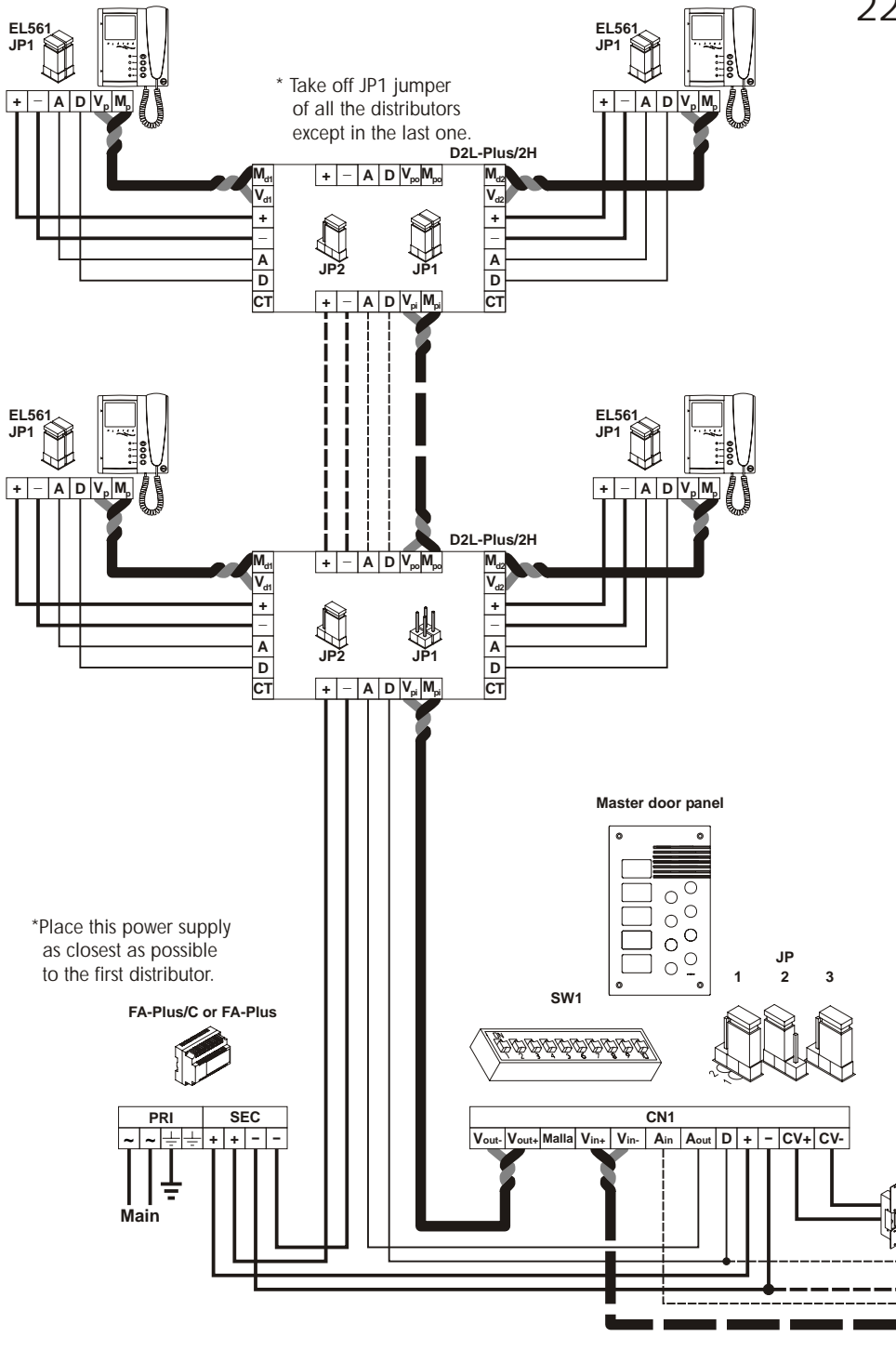

### V

Video installation without coaxial cable.

The installation diagram shows the connection of a video system with one or several door panels for the same building. If the system has one door panel only, override the wiring to the second door panel. If the system has more than one door panel, wire the second panel as shown on the diagram. In case of more than two door panels, wire them as the second is connected.

**IMPORTANT:** For this type of installation, the door panels must have plugged an EL560 module in each and the monitors must have an EL561 plugged in each. If the CTO terminal is wired, only the distributor connected to the called monitor will be active. Change the JP2 jumper position of the distributors to enable this function.

SECTIONS CHART	Distance	
	50m.	150m.
Terminal	50m.	150m.
+, -, CTO, CT, CV+, CV-	1,00mm <sup>2</sup>	2,50mm <sup>2</sup>
A <sub>in</sub> , A <sub>out</sub> , A, D	0,25mm <sup>2</sup>	0,25mm <sup>2</sup>
V <sub>in+</sub> , V <sub>out+</sub> , V <sub>p</sub> , M <sub>p</sub>	CAT-5	CAT-5

For longer distances than the specified contact with your distributor.

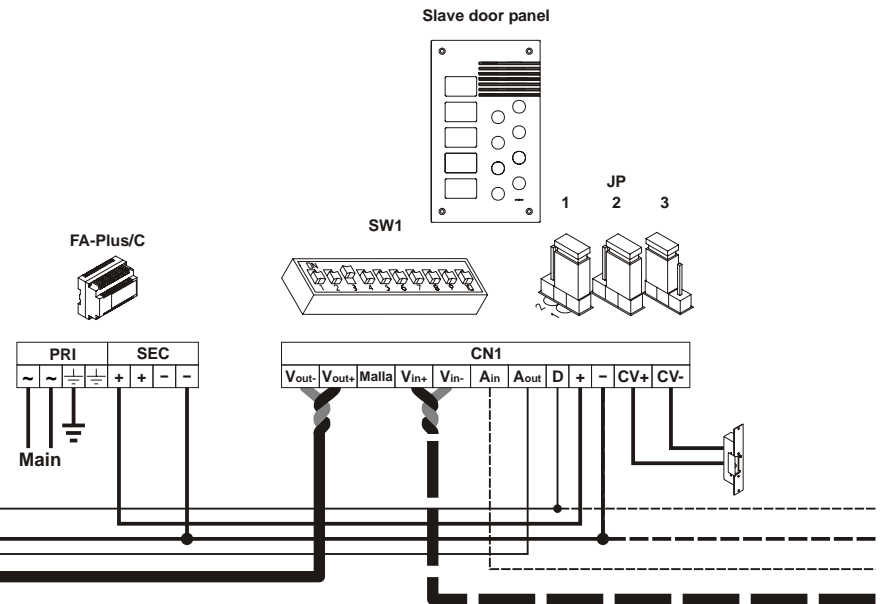

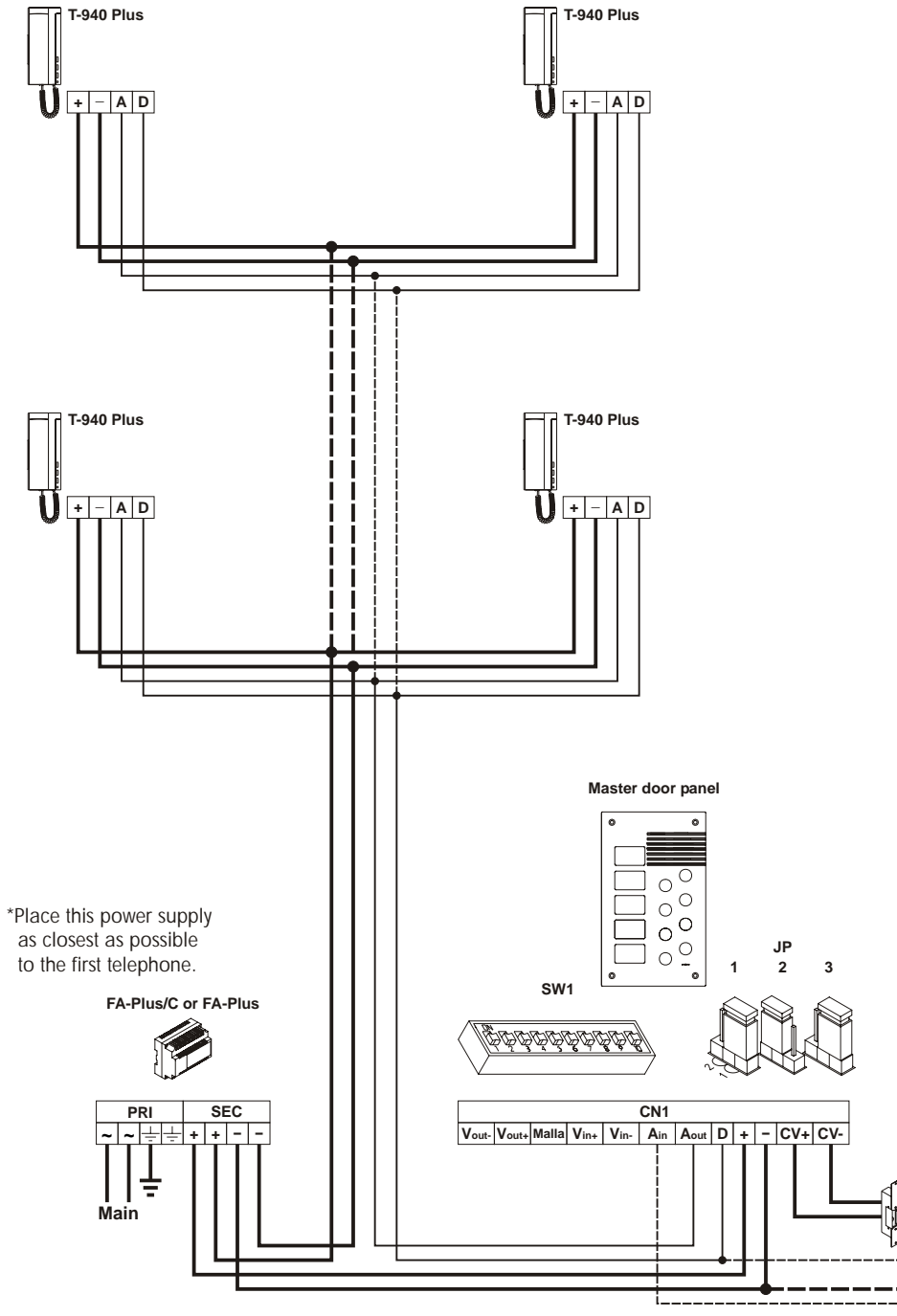

\*Place this power supply as close as possible to the first telephone.

FA-Plus/C or FA-Plus

Master door panel

Slave door panel

## A audio installation.

The installation diagram shows the connection of an audio system with one or several door panels for the same building.

If the system has one door panel only, override the wiring to the second door panel.

If the system has more than one door panel, wire the second panel as shown on the diagram.

In case of more than two door panels, wire them as the second is connected.

SECTIONS CHART	Distance	
	50m.	150m.
+, -, CV+, CV-	1,00mm <sup>2</sup>	2,50mm <sup>2</sup>
A <sub>in</sub> , A <sub>out</sub> , A, D	0,25mm <sup>2</sup>	0,25mm <sup>2</sup>

For longer distances than the specified contact with your distributor.

FA-Plus/C

SW1

PRI SEC

Vout- Vout+ Malla Vin+ Vin- AIn Aout D + - CV+ CV-

Main

Vout- Vout+ Malla Vin+ Vin- AIn Aout D + - CV+ CV-

Vout- Vout+ Malla Vin+ Vin- AIn Aout D + - CV+ CV-

**E**xternal lock release activation.

The lock release can be activated at any moment by using an external push button, that must be connected between 'CV-' y '-' terminals of the main module. This function will allow to exit from the building being not necessary the use of a key.

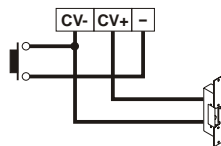

**A**uxiliary devices activation.

To activate auxiliary devices the use of a SAR-90 relay unit will be required. If this device is shared for all the monitors, link their A1 terminal and use just one relay unit. In case that each monitor has its own application use a SAR-90 relay unit for each monitor and don't link the A1 monitor terminals. To activate this function, press the monitor push button at any moment with no dependence of the handset position. Usual applications are the activation of stairs light, second lock release, ...

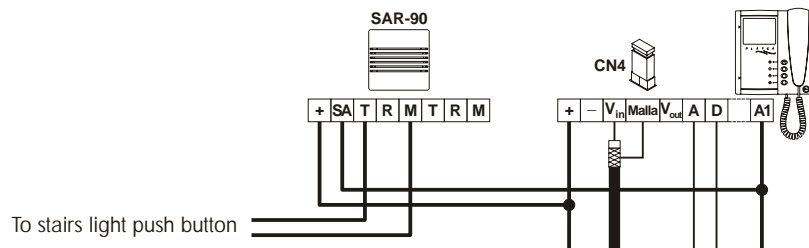

The use of a TF-104 transformer will be necessary to activate a second lock release. **IMPORTANT:** the lock release must be 12Vc.a. type.

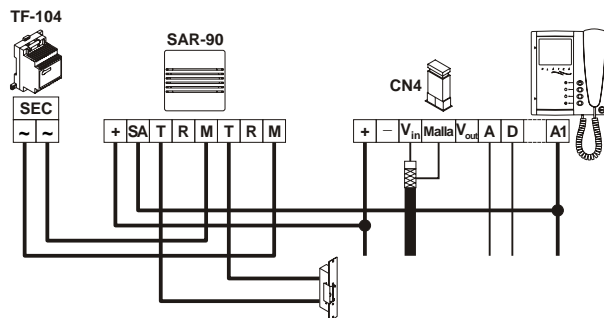

**I**ntercom function.

Platea Plus monitor and T-940 Plus telephone have intercom facility between two units of the same apartment. To enable this function check the following conditions:

- One of the units has been configured as master and the other unit as slave with intercom, as described on pages 15 and 18.
- In case to intercom one monitor with one telephone, configure the monitor as master..
- Link the INT terminal of the units, as it is shown on the enclosed diagram.

To establish an intercom communication lift the handset and press the intercom push button; acoustic tones will be reproduced on the handset confirming the call is in progress or that the other unit is communicating with the door panel. To establish communication lift the handset of the called unit. If during an intercom communication a call is made from the door panel, acoustic tones will be heard on the master unit handset and the picture will appear in case of a monitor; press the intercom push button of the master unit to establish communication with the door panel, or press the door release push button to activate the lock release.

The reproduced acoustic tones are different depending on their provenance, that allows the user to distinguish where the call is made from.

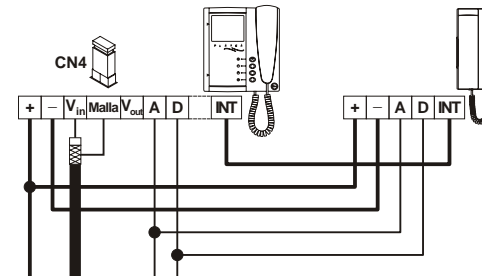

**C**onnecting the Shiner Plus monitor to a video recorder or TV.

If your TV or video recorder have a SCART connector, it will be possible to view the picture from the door panel on the TV screen.

Remove the end of line jumper, that's placed on the CN4 connector. Connect the coaxial cable between terminals 17 (shield) and 20 (hot) of the SCART connector.

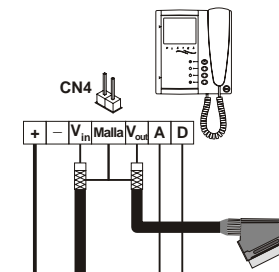

### A ctivation of a second camera.

The use of a SAR-90 relay will be required to activate a second camera and an internal modification on the monitor shall be done, as it's described on page 11.  
 This facility disables the intercom function. If both functions are required, use A1 terminal to activate the second camera.  
 To activate this function, press  $\odot$  monitor push button at any moment with no dependence of the handset position.  
 If this device is shared for all the monitors, link their 2C terminal and use just one relay unit.  
 In case that each monitor has its own camera use a SAR-90 relay unit for each monitor and don't link the 2C monitor terminals.  
 This push button can be used to activate other auxiliary devices, as the A1 terminal is used. Usual applications are the surveillance of the elevator entrance, reception hall, ...

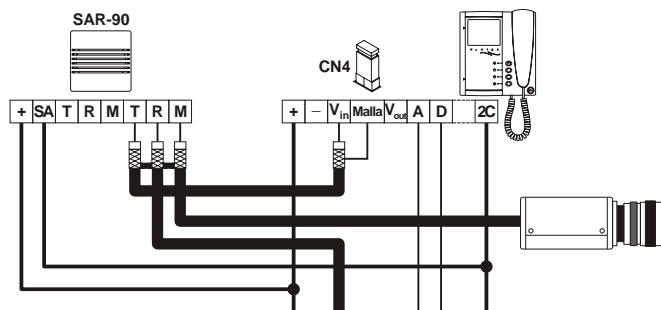

### D oor bell push button connection.

The Platea Plus monitor and the T-940 Plus telephone can be used to receive the calls made from the apartment door, saving the use of a bell. Wire the push button of the apartment door to the 'HZ-' and '-' monitor or telephone terminals.  
 The reproduced acoustic tones are different depending on their provenance, that allows the user to distinguish where the call is made from. If during a conversation a call is made from the apartment door, acoustic tones will be reproduced on the handset to advise that someone is calling.

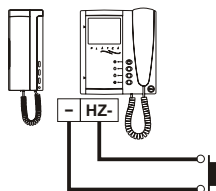

An easy way to check that the system is working properly is to disconnect the wiring from the door panel and to check a monitor or telephone directly connected to the door panel.

No shortcircuit will damage the connected units, with the exception of a shortcircuit between CTO and '-' monitor or distributor terminals.

- ☞ Nothing operates.
  - ☹ Check the output power supply voltage between '-' and '+' terminals: it should have 17,5 to 18,5Vd.c. If not, disconnect the power supply from the installation and measure again. If it's correct now, it means there is a short circuit in the installation: disconnect the power supply from mains and check the installation.
  - ☹ Check that 'D' terminal is not shortcircuited with '-' or '+' terminals.
  - ☹ Check that 'D' terminal hasn't been changed by 'A' terminal somewhere in the installation.
- ☞ Inappropriate audio level.
  - ☹ Adjust the level volumes as shown on page 8. In case of feedback, reduce the audio levels until feedback fade out. If feedback don't dissapears refer to the following hint.
- ☞ Continuous audio feedback.
  - ☹ Check that 'A' terminal is not shortcircuited with other terminals.
- ☞ Door open function no operates.
  - ☹ Remember that this function is only available during call and communication progresses.
  - ☹ Disconnect the lock release from the main module and short-circuit terminals '-' and 'CV-': at that moment the output voltage between terminals 'CV+' y 'CV-' should be 12Vd.c. If it's so check the lock release and its wiring.
- ☞ The system cannot be programmed.
  - ☹ Check that the switch number 2 of the configuration dip switch is set to ON (see page 7) and that the programming steps are correctly followed.
  - ☹ Check that 'D' terminal is not shortcircuited with other terminals.
- ☞ Some units don't receive calls.
  - ☹ Remember that each apartment must have a master unit only. Check that the units are switched on and correctly programmed.





[golmar@golmar.es](mailto:golmar@golmar.es)  
[www.golmar.es](http://www.golmar.es)



Golmar se reserva el derecho a cualquier modificación sin previo aviso.  
Golmar se réserve le droit de toute modification sans préavis.  
Golmar reserves the right to make any modifications without prior notice.