



TECHNOLOGY



Soul kit



USER MANUAL

G2+ 2-wire installation  
Art 7 monitor



**CONTENTS**

---

Contents .....	2
Recommendations.....	3
System operation .....	3
Optional .....	3
FA-G2+ power supply.....	4
Description .....	4
Installation .....	4
Soul panel .....	5 to 8
Description .....	5
Installation .....	6
Installation terminals .....	6
Configuration switches.....	7
Setting the audio level .....	7
Programming the proximity reader .....	8
Art 7/G2+ monitor.....	9 to 24
Description .....	9
Installation .....	10
Installation terminals .....	10
Configuration switches.....	10
Main menu .....	11
Settings menu.....	12 to 16
Door panel call screen.....	17
Communication screen .....	18
Image and communication settings .....	19
Intercom menu.....	20 to 21
Recordings menu .....	22 to 24
Wiring diagrams.....	25 to 29
Cross sections and distances.....	25
One apartment with one access panel and one monitor .....	25
One apartment with two access panels and one monitor .....	25
One apartment with up to two access panels and up to four monitors in cascade .....	26
One apartment with up to two access panels and up to four monitors in distribution .....	26
Two apartments with up to two access panels and up to four monitors in cascade .....	27
Four apartments with up to two access panels and up to four monitors in cascade.....	28
Four apartments with up to four access panels and up to four monitors in cascade .....	29
Connection of a lock release.....	30
Connection of an auxiliary device at the relay output .....	30
Connection of an exit button .....	31
Connection of an external camera .....	31
Connection for an apartment door button.....	31
Special codes .....	32 to 34
Cleaning the monitor .....	35
Cleaning the door panel.....	35
Compliance.....	36

## RECOMMENDATIONS

---



- Preferably use a Golmar **RAP-GTWIN/HF** cable (2x1mm<sup>2</sup>).
- The wiring must run at least **40cm away from any other wiring.**
- **Always disconnect the power supply** before making modifications to the device.
- The installation and handling of these devices must be carried out by **authorised personnel.**
- Check all connections before starting the device.
- Always follow the instructions contained in this manual.





## SYSTEM OPERATION



---

To make a call, the visitor needs to press the button for the apartment, an audible tone indicates that the call is being made and LED  on the door panel illuminates. At this moment, the apartment's monitor(s) receive(s) the call. If the visitor presses the button for another apartment by mistake, the call can be cancelled by pressing the button for the correct apartment.

In systems with two access doors, the other door panel automatically disconnects; if another visitor attempts to call, a number of telephone tones will indicate that the system is busy and LED  on the door panel will illuminate.

Upon receiving the call, the image will appear on the screen of the master monitor (and slave 1, if it exists) without the visitor knowing and icon  displayed on the screen will blink green. To view the image from slave monitors 2 or 3, press one of the hidden buttons (located above the raised dots for the visually impaired) of the monitor to display the image. If the call is not answered within 45 seconds, door panel LED  will turn off and the system will become free.

To establish communication, press the hidden button below off-the-hook icon  shown on the screen. Door panel LED  will illuminate. Communication will last for 90 seconds or until the hidden button below on-the-hook icon  shown on the screen is pressed. When communication has ended, door panel LED  will turn off and the system will become free.

To open door  or activate auxiliary output  of the door panel, press the hidden button below the corresponding icon displayed on the screen. A single press activates the lock release or auxiliary output for 3 seconds (with the possibility of setting it to between 0.5 and 10 seconds, see pp. 32-34), and LED  on the door panel illuminates.

Detailed operation of the monitor is described on pp. 11-24.

The owner of the apartment can activate the lock release by holding the proximity key over the reader. If the proximity key is held for three seconds, the auxiliary relay output will be activated.

## FA-G2+ POWER SUPPLY

## Description

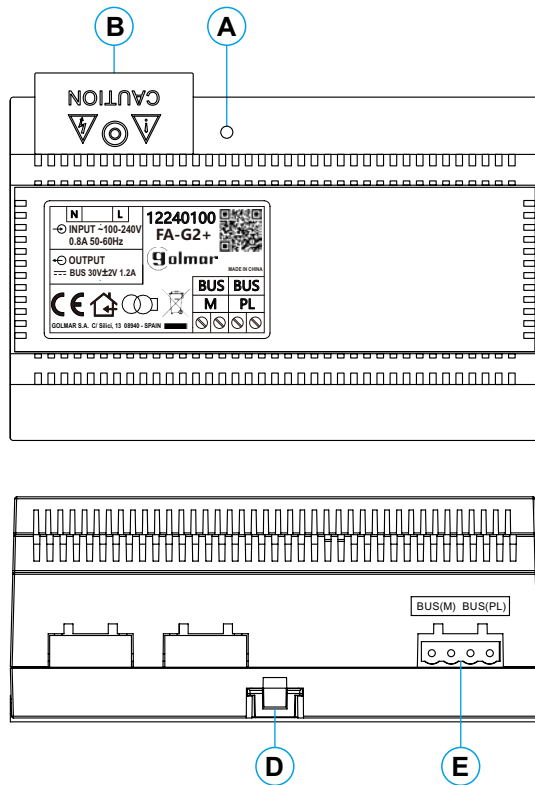

- A. On/off indicator light.
- B. Protective current input cover.
- C. Detail of current input terminals without protective cover.
- D. Fastening tab on DIN rail.
- E. Installation terminals.

## Installation

The fitting and handling of the power supply must be carried out by authorised personnel in the absence of electrical current.

Install the power supply in a dry, protected and ventilated location. Make sure that the vents are not obstructed. Use a DIN 46277 rail for fastening (8 elements).

Note that current regulations stipulate that the power supply must be protected by a circuit breaker.

To prevent electric shock, do not remove the protective cover without first disconnecting the power supply. Replace it once all connections have been made.

Connect the wires to the installation terminals following the instructions in the diagrams.

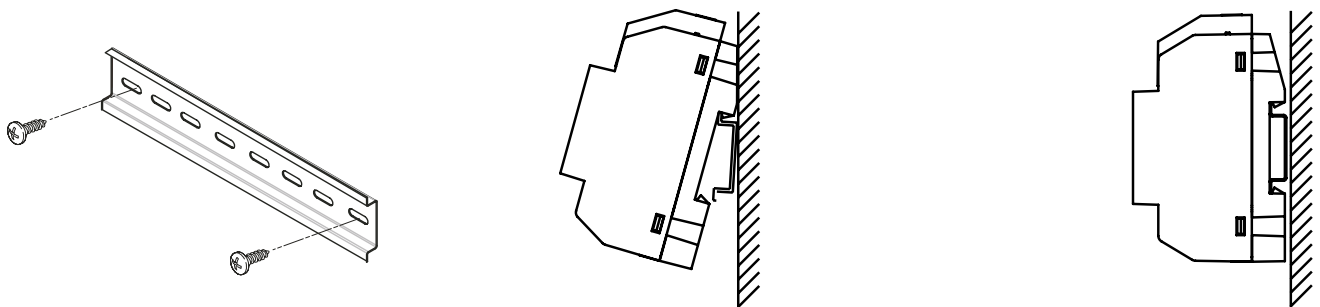

SOUL PANEL

Description

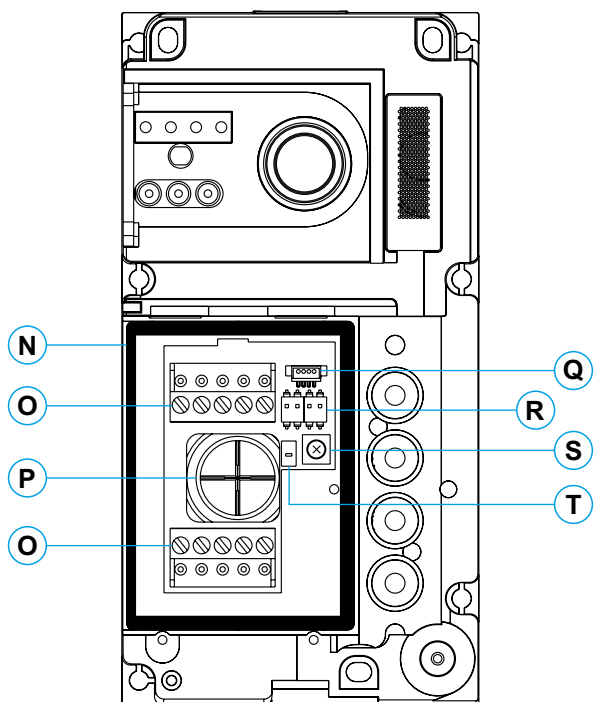
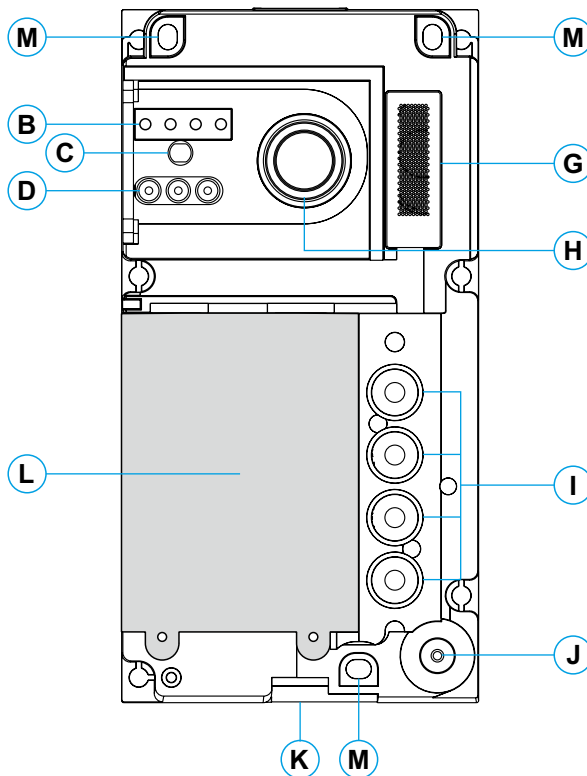
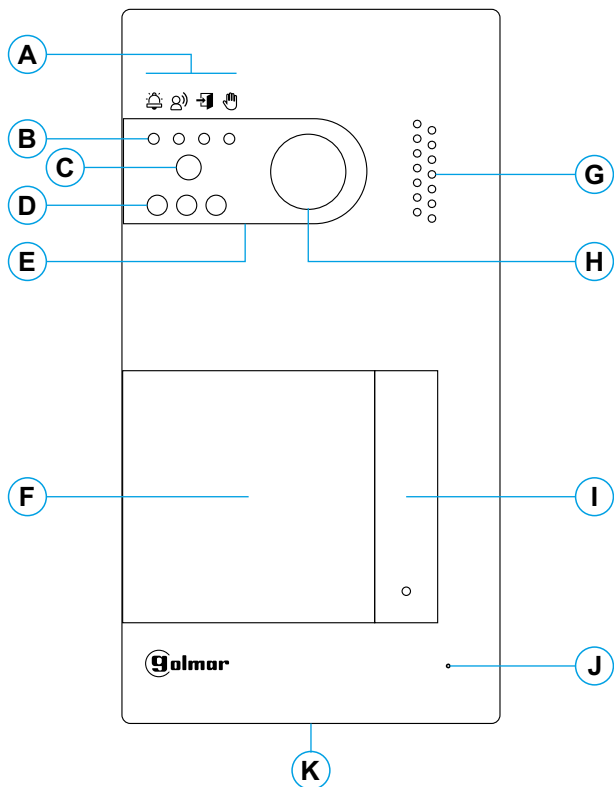

- A. System status icons:
  - 📞 Call in progress.
  - 📞 Communication established.
  - 🔒 Lock release activated.
  - 👤 System busy.
- B. System status indicator lights.
- C. Ambient lighting sensor.
- D. Night viewing lighting.
- E. Protective polycarbonate.
- F. Proximity card reader.
- G. Speaker grill.
- H. Colour camera.
- I. Call button(s).
- J. Microphone hole.
- K. Front fixing screw.
- L. Proximity reader.
- M. Wall fixing hole (x3). **Do not overtighten the fixing screws.**
- N. Proximity reader gasket.
- O. Installation terminals.
- P. Cable grommet.
- Q. Proximity reader connector.
- R. Configuration switches.
- S. Volume control potentiometer.
- T. Proximity reader configuration button.

## SOUL PANEL

### Installation

The door panel has been designed to withstand diverse environmental conditions. It is however advisable to take extra precautions to prolong its service life, such as locating it in a covered area.

For optimum image quality, avoid direct contact from light sources (sunshine, street lights, etc.).

For correct installation: (locate the top of the door panel at a height of 1.65m).

1. Remove the metal front piece of the door panel by loosening the bottom screw with the Allen key supplied. On the back of the front piece, you will find the button personalisation label.
2. Remove the screws that secure the proximity reader.
3. Present the door panel to the wall, positioning the top at 1.65m. Pass the installation cables through the cable grommet.
4. Drill three 6mm holes at the indicated points (M), see p. 5. Insert the plugs supplied and fix the door panel to the wall using the screws supplied.
5. Connect the cables to the removable terminals following the instructions in the installation diagrams.

Before replacing the proximity reader and closing the door panel, perform the necessary settings (proximity key programming, audio level setting, etc.), as indicated throughout this manual. Make sure that the proximity reader gasket is properly fitted.

### Installation terminals (O)

For ease of installation, the installation terminals are removable and supplied in a separate bag. Once the terminals are wired, place them in position.

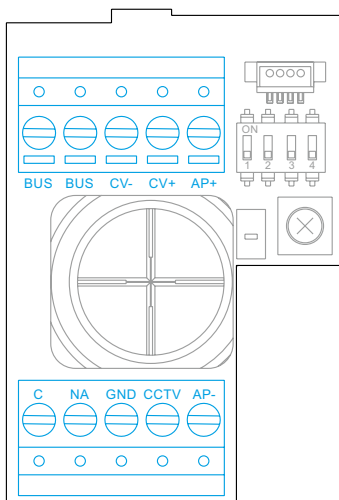

BUS, BUS: communications bus (non-polarised).

CV-, CV+: lock release output 12Vdc (maximum 270mA).

AP+, AP-: remote activation button connection. **Note: For correct operation, the monitor's address 1 must be connected to the Bus**

C, NA: potential-free relay output (maximum 6A/24V).

GND, CCTV: input for external analogue camera.

SOUL PANEL

Configuration switches (R)

Configuration changes should be made with the equipment turned off. If they are performed with the equipment turned on, disconnect it for 10 seconds after any modification.

All switches are factory set to OFF.

**Note: Configuration switches for the SOUL/1, SOUL/2, and SOUL/4 with version V04 and next.**

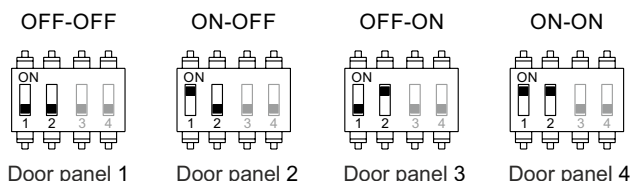

**Switch 1 and 2.**  
Defines the door panel address.

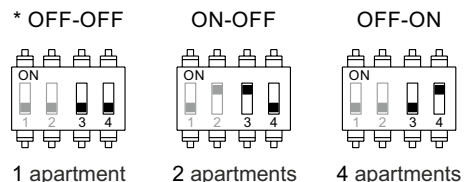

**Switches 3 and 4.**  
Define the number of apartments:  
1: all buttons call apartment 1.  
2: the two bottom buttons call apartment 1, the two top buttons call apartment 2.  
4: each button calls one apartment.

\* Same value as setting them to ON-ON.

Setting the audio level

If the audio volume on the door panel after starting up the device is not adequate, use the volume control potentiometer (S). This setting affects the communication and confirmation tone audio level.

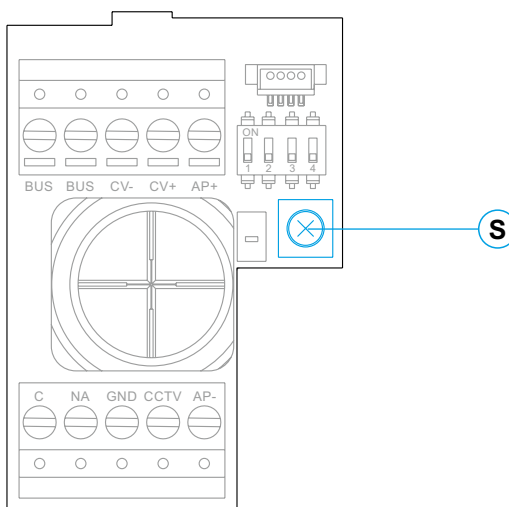

## SOUL PANEL

### Programming the proximity reader (L)

Make sure that the device is powered and the reader is connected to the door panel (Q).

To add user keys (up to 60) to the memory of the proximity reader, it is necessary to create a programming key and a user registration key. In order to facilitate identification, we recommend using the yellow key to programme and the blue key to register users. Use the grey ones as user keys.

#### Creating programming and registration keys.

**NOTE: This process completely deletes the memory of the proximity reader.**

Press the programming button of the proximity reader (T): the door panel will emit six short tones. Within ten seconds, hold the programming key up until the door panel emits a short confirmation tone and then hold the user registration key up until the door panel emits a long confirmation tone. If no key is held up within ten seconds of pressing the programming button, the door panel will emit a long tone and the memory will have been completely deleted.

Once the programming and registration keys have been created, the addition and deletion of user keys can be done with the door panel closed.

#### Adding user keys.

Hold the registration key up to the reader: the door panel will emit four short tones. One by one, hold up the user keys that you wish to add until a short tone is emitted for each key added. Ten seconds after adding the last key, the door panel will emit a long tone to confirm completion of the process.

#### Deleting all user keys.

Hold the programming key up to the reader: the door panel will emit four short tones. Hold up one added user key (registered in the previous step) until the door panel emits a long tone to confirm the deletion of all user keys. After ten seconds, if the registration key has not been held up, the door panel will emit a long tone to confirm completion of the process.

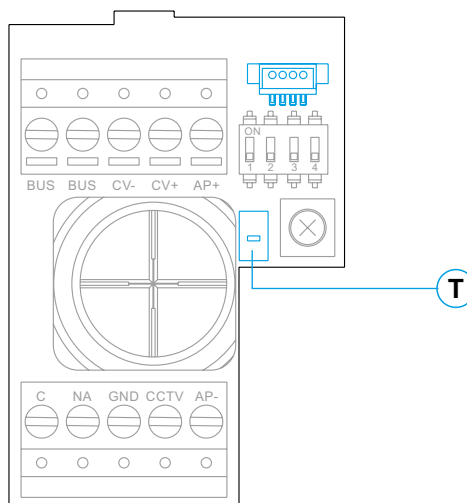



ART 7/G2+ MONITOR

Description

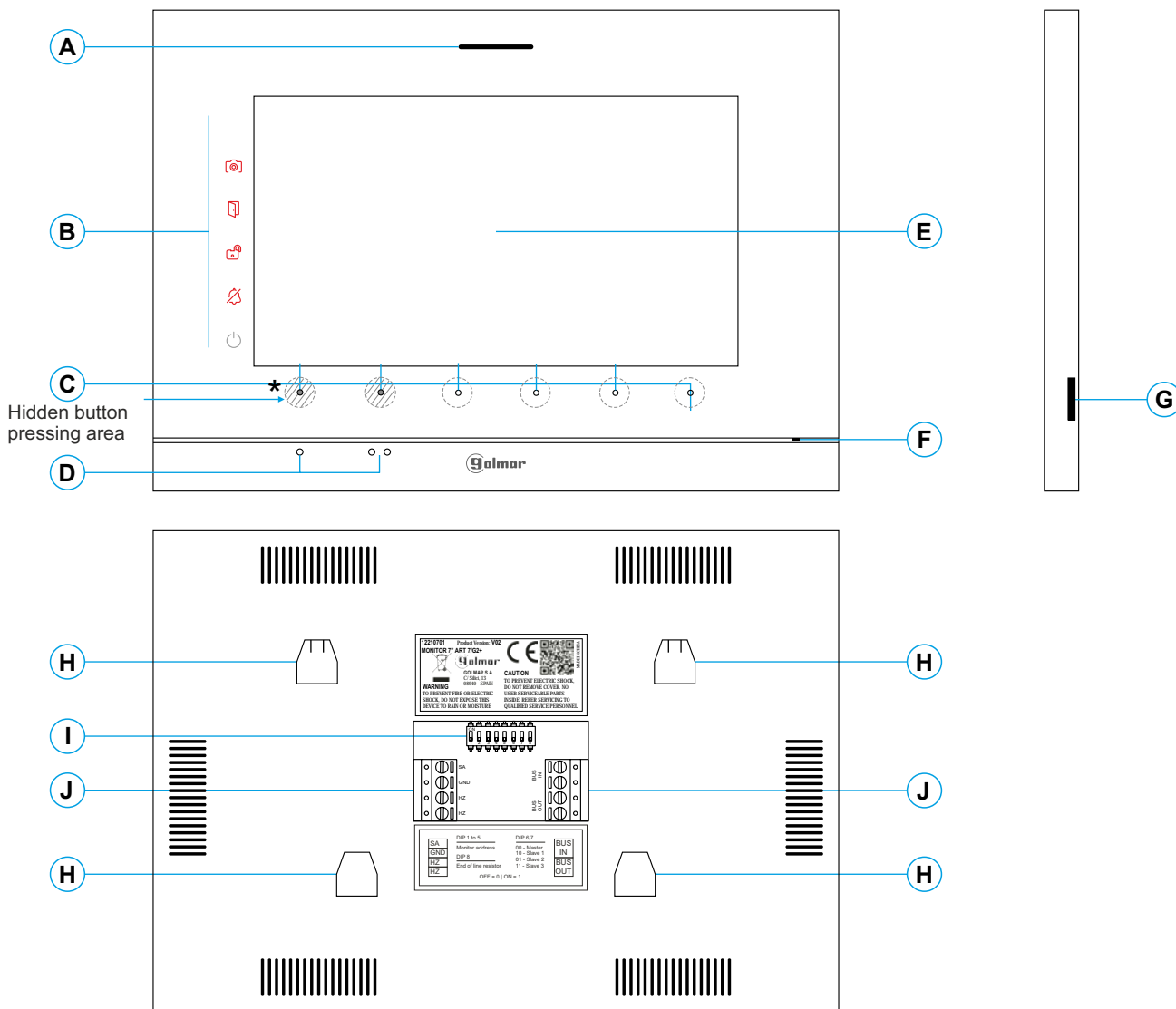

- A.** Speaker.
- B.** Notification icons:
  - ⏻ Power on indicator.
  - 🚫 Do not disturb.
  - 🔌 Auxiliary relay activated.
  - 🚪 Door opening.
  - 📷 New image/video.
- C.** Hidden button indicator LEDs\* 📶 :  
 To access the main menu (monitor in standby), press either of the 2 hidden buttons with indicator LEDs illuminated, located above the raised dots for the visually impaired (see p. 11).  
 In call/communication: an LED shows the location of each of the hidden buttons.  
 The function of each hidden button is shown on the monitor screen with an icon located just above each button (see pp. 11-24).
- D.** Raised dots for the visually impaired.  
In standby:  
 Above the raised dots for the visually impaired ●/●● are the hidden buttons that access the main menu.  
In call:  
 ● Above this raised dot is the hidden 'Start/end communication' button.  
 ●● Above this raised dot is the hidden 'Door opening' button.
- E.** 7" TFT colour screen.
- F.** Microphone.
- G.** Micro SD card slot (not included).  
 Type: MicroSD Class 10 from 4GB to 128GB.
- H.** Wall mounting connector fixing (x4).
- I.** Configuration switches.
- J.** Installation terminals.

ART 7/G2+ MONITOR

Installation

Avoid dusty or smoky environments or locations near sources of heat.

For proper installation, use the template supplied with the product.

1. Position the top of the template at a height of 1.65m.
2. If you are going to use an embedding box to pass the wiring through, make sure that it is in line with the holes corresponding to the box model chosen and fix the connector. If you prefer to fix the connector directly to the wall, make four 6mm holes at the points indicated (A), insert the wall plugs supplied and screw in the connector.
3. Pass the installation wires through the middle hole and connect them to the removable terminals as shown in the wiring diagrams. Before connecting the removable terminals to the monitor, configure the switch as indicated below.
4. Connect the removable terminals to the monitor and place the monitor in front of the connector, making sure the fixings line up. Move the monitor downwards to secure it.

Installation terminals (J)

For ease of installation, the installation terminals are removable and supplied in a separate bag. Once the terminals are wired, place them in position.

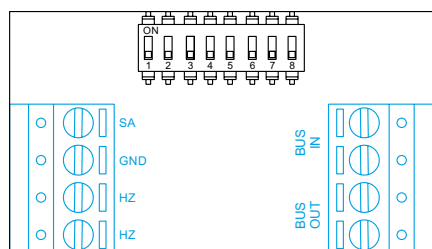

BUS IN: Communication bus input to monitor (non-polarised).

BUS OUT: Communication bus output to additional monitor (non-polarised).

SA, GND: Auxiliary call repeater output (max 50mA/12V), relay SAR-12/24.

HZ, HZ: Apartment front door button input:

Connect only on the master monitor. The signal received is then transmitted to the slave monitors in the same apartment through the BUS.

Configuration switches (I)

Switches 1 to 5.

These assign the address of the corresponding monitor to its call button on the door panel. Switches 4 to 5 must remain in the OFF position.

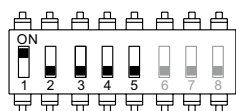

Apartment 1

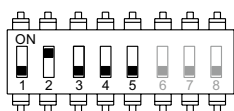

Apartment 2



Apartment 3



Apartment 4

Switches 6 and 7.

These define whether the monitor is master or slave. Each apartment must have one master monitor, and only one.



Master

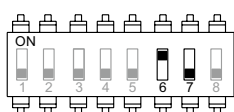

Slave 1



Slave 2

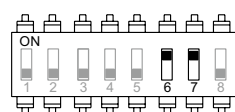

Slave 3

Switch 8.

This activates the end-of-line resistance in the ON position. Activate it in monitors where the bus cable ends. Deactivate it only in intermediate monitors.

## MONITOR ART 7/G2+

## Main menu

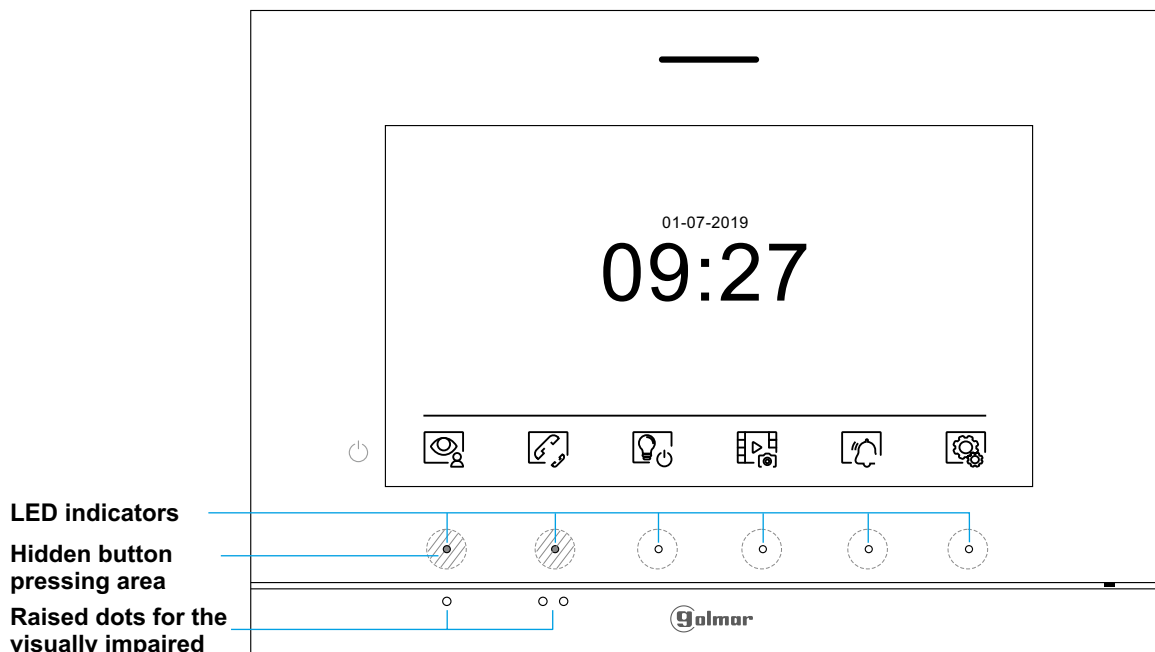

If the device is in standby (screen switched off), to access the main menu, press either of the 2 hidden buttons with indicator LEDs illuminated (located above the raised dots ●/●● for the visually impaired) on the monitor. Then press the hidden button located just below the corresponding icon. The device will return to standby mode after 30 seconds without activity.



Press the hidden button below icon  to display the image from the door panels and cameras connected to the system. Note: This enables the door panel camera to be changed, the audio on the corresponding door panel to be activated and the door to be opened (see p. 17).



Press the hidden button below icon  to access the menu of the intercom between other monitors in the same apartment or other apartments (see pp. 20-21).



Press the hidden button below icon  to display the list of images recorded in the memory of the device. If a MicroSD card is inserted in the monitor, images/videos will be recorded on the MicroSD card (see pp. 22-24).







There are no images/videos pending viewing.



There are images/videos pending viewing.



Indicates that the inserted Micro SD card must be formatted from the monitor. Access this function by pressing the hidden button below icon  to access the Micro SD card format menu, then press the hidden button below icon  to start formatting the Micro SD card. To return to the main menu, press the hidden button below icon . To exit without formatting, press the hidden button below icon .



Press the hidden button below icon  to make changes to the system settings (see pp. 12-16).



No function.



Press the hidden button below icon  for 3 seconds to enable and for 1 second to disable the 'Do not disturb' function: If the monitor is in 'Do not disturb' mode, the ringtone on the monitor does not sound when a call is received and the notification icon will illuminate.



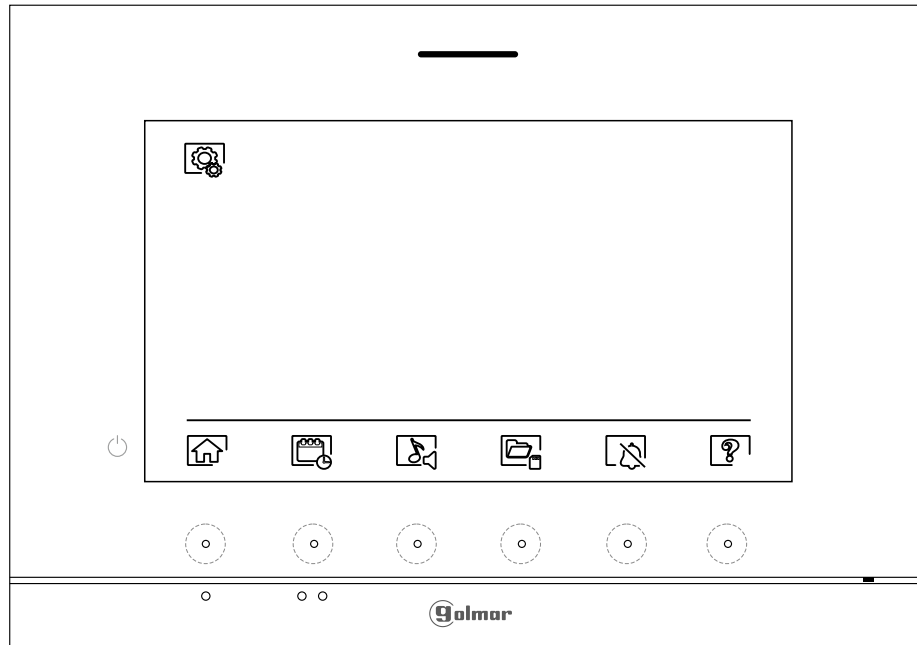

ART 7/G2+ MONITOR

Settings menu



Returning to the main menu: Press the hidden button below icon  to return to the main menu.





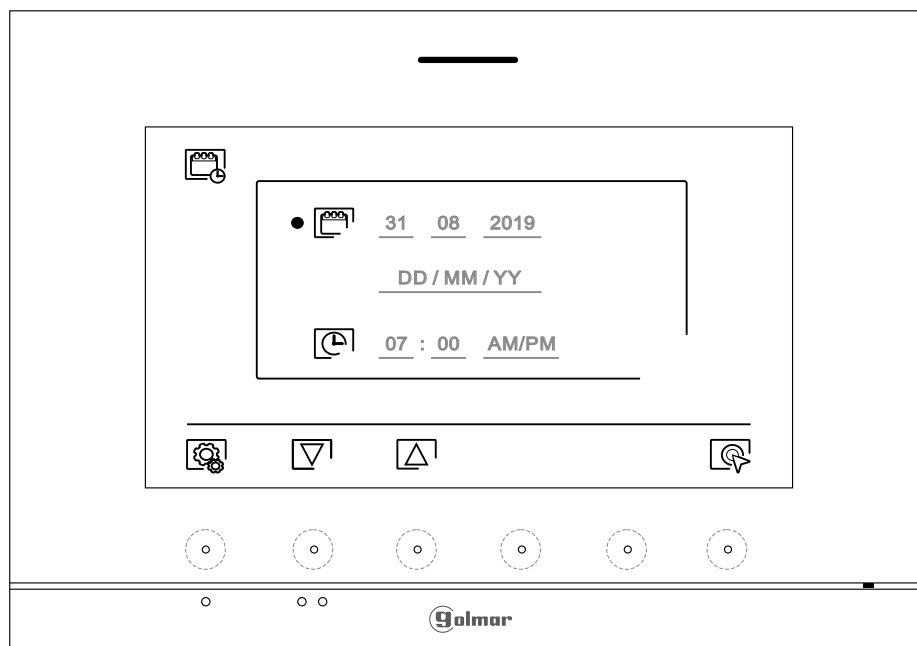



Setting the monitor's date and time, as well as the presentation format: Press the hidden button below icon  to access the settings screen. Go to the option to be modified by pressing the hidden buttons below corresponding icons /, then select the option to modify by pressing the hidden button below icon .







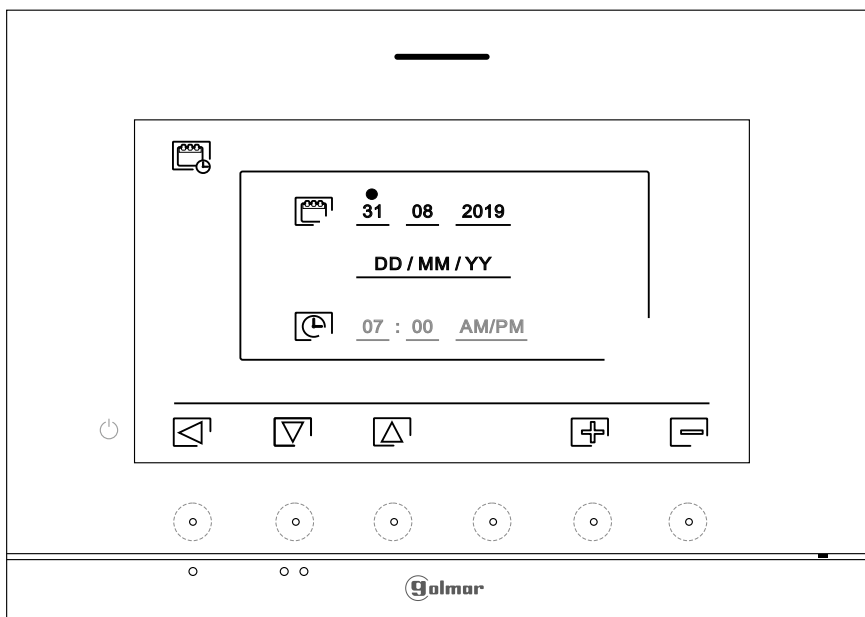

Continued from previous page.

**ART 7/G2+ MONITOR**

**Settings menu**

Select the field to modify by pressing the hidden buttons below corresponding icons  / , then press the hidden buttons below corresponding icons  /  to adjust the value/format. Validate the changes made by pressing the hidden button with icon . After setting the desired values, press the hidden button below icon  to return to the settings menu.



**Selecting the melody and call volume:** Press the hidden button below icon  to access the settings screen. In order to identify the origin of the calls when you are not in front of the monitor, select different melodies and the desired call volume. Go to the option to be modified by pressing the hidden buttons below corresponding icons  / , then press the hidden buttons below corresponding icons  /  to select the melodies and desired call volume. Press the hidden button below icon  to validate the changes made and return to the settings menu.

**Important: Door panels  and  have no use in house applications with SOUL door panels.**

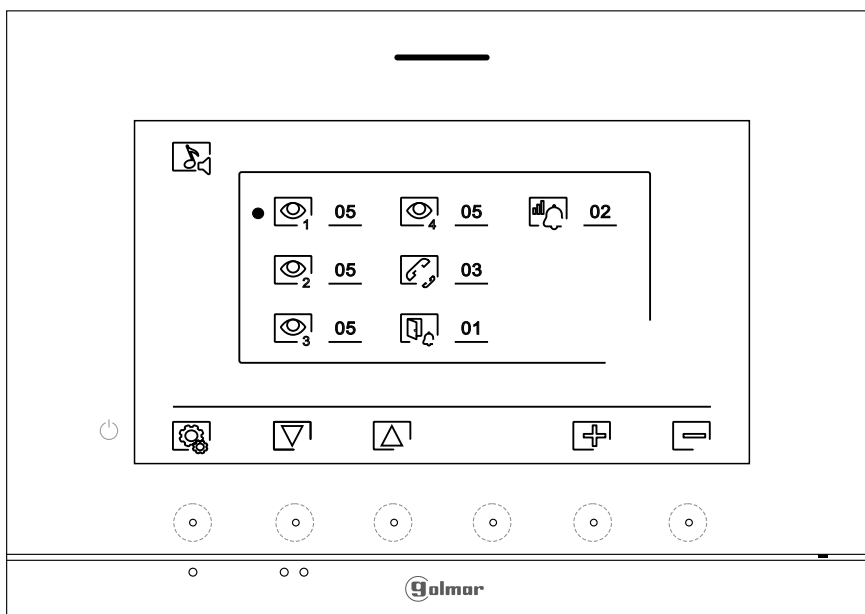

## ART 7/G2+ MONITOR

## Settings menu



Automatically deleting images/videos, image recording mode, internal memory and Micro SD card: Press the hidden button below icon to access the settings screen. In some countries, the law does not permit the storage of images or videos for more than 30 days after recording. The automatic deletion function performs this task for you. You can disable this function if your country's legislation does not require it, or under your responsibility.

If you have not inserted a Micro SD card into your monitor, only still images can be recorded in the internal memory of the monitor (up to 100). If you have inserted one, the images and videos will always be recorded on the card, and the images in the internal memory cannot be displayed until you copy them to the card.

From this menu, you can select the image recording mode, delete contents, copy from the internal memory to the Micro SD card and format the card. Any of these actions (copy/delete) will require confirmation.

Press the hidden button below icon to return to the settings menu.

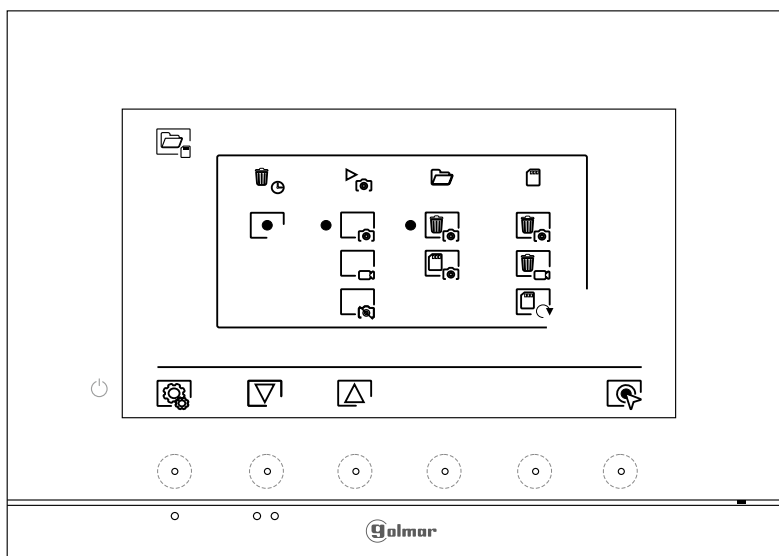

In some countries, the law does not permit the storage of images or videos for more than 30 days after recording. The automatic deletion function performs this task for you. You can disable this function if your country's legislation does not require it, or under your responsibility. To disable this function, go to the option to be modified by pressing the hidden buttons below corresponding icons / , then press the hidden button below icon to enable/disable the automatic deletion function. Press the hidden button below icon to return to the settings menu.



To select the image recording mode during the reception of a call: still image , video and without recording , go to the desired option by pressing the hidden buttons below corresponding icons / , then press the hidden button below icon to select the recording mode. To return to the settings menu, press the hidden button below icon .



If you have inserted a Micro SD card into the monitor, you can copy previously recorded still images on the monitor to the new Micro SD card and then delete the still images from the internal memory of the monitor. Press the hidden button below icon to return to the settings menu.



To copy the still images recorded on the monitor to the Micro SD card, go to the option with icon by pressing the hidden buttons below corresponding icons / . Press the hidden button below icon to access the card format menu, then press the hidden button below icon to perform this function.













To delete the still images recorded in the internal memory of the monitor, go to the option with icon by pressing the hidden buttons below corresponding icons / . Press the hidden button below icon to access the card format menu, then press the hidden button below icon to perform this function.







Continued from previous page.







## ART 7/G2+ MONITOR



### Settings menu

 If you have inserted a Micro SD card into the monitor, you can delete the still images  and videos  recorded on the Micro SD card. The monitor has the option to format the Micro SD card. Press the hidden button below icon  to return to the settings menu.

 To delete the still images recorded on the Micro SD card, go to the option with icon  by pressing the hidden buttons below corresponding icons  / . Press the hidden button below icon  to access the still image deletion menu, then press the hidden button below icon  to perform this function.









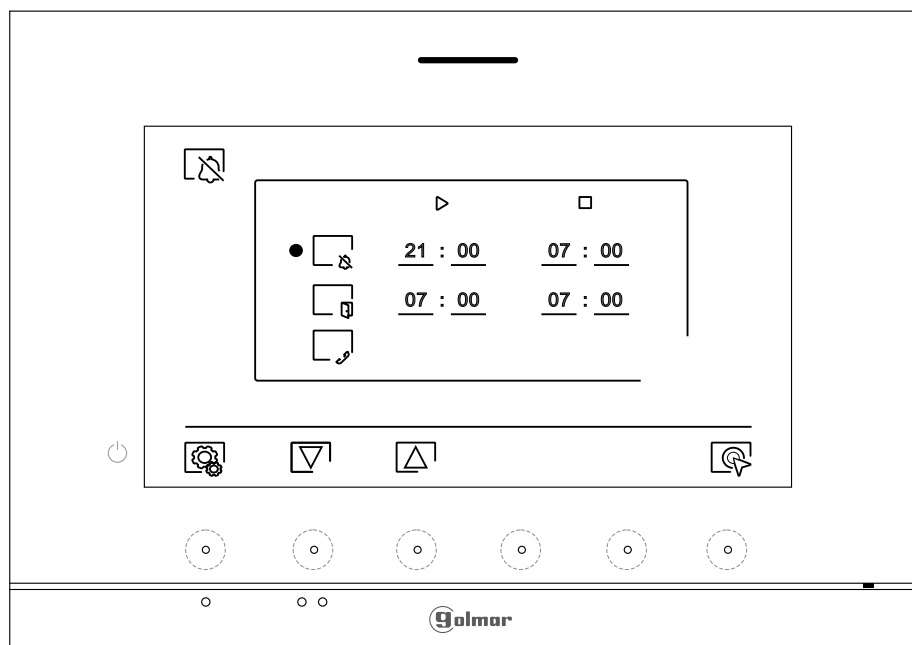

 To delete the videos recorded on the Micro SD card, go to the option with icon  by pressing the hidden buttons below corresponding icons  / . Press the hidden button below icon  to access the video deletion menu, then press the hidden button below icon  to perform this function.

 To format the Micro SD card, go to the option with icon  by pressing the hidden buttons below corresponding icons  / . Press the hidden button below icon  to access the card format menu, then press the hidden button below icon  to perform this function.

 **'Do not disturb' and enable/disable intercom settings mode:** Press the hidden button below icon  to access the settings screen. You can set a period of time during which the monitor will not sound when receiving calls. To do so, enable the timer function and choose the time period. From the main menu, you can enable and disable the 'Do not disturb' function regardless of the timer status.

If you wish to be contacted from another monitor in another apartment, you must enable the intercom function between apartments .













 To set a period of time during which the monitor will not sound when receiving calls, go to the option with icon  by pressing the hidden buttons below corresponding icons  / , select the option to be modified by pressing the hidden button below icon , then select the field to be modified by pressing corresponding buttons  /  and modify the desired period of time by pressing the hidden buttons below corresponding icons  / , and finally validate the changes made by pressing the hidden button below icon . Press the hidden button below icon  to return to the settings menu.

Continued from previous page.





## ART 7/G2+ MONITOR

### Settings menu



To activate and set a period of time for the automatic opening of door  (after 3 seconds of receiving a call from the door panel), go to the option with icon  by pressing the hidden buttons below corresponding icons / and select the automatic door opening function activation option by pressing the hidden button below icon . Then, if you wish to set a period of time for opening the door, select the field to be modified by pressing corresponding buttons /, modify the desired period of time by pressing the hidden buttons below corresponding icons / and validate the changes made by pressing the hidden button below icon . Press the hidden button below icon  to return to the settings menu. **(This function is disabled by default. To enable it, see pp. 32-34).**



To enable/disable the intercom function between apartments, go to the option with icon  by pressing the hidden buttons below corresponding icons /. Then press the hidden button below icon  to enable/disable this function. Press the hidden button below icon  to return to the settings menu. **(This function is disabled by default).**







The 'About' screen provides information about the monitor, such as the software version, address and whether it is master or slave (M, S1, S2 or S3).

It enables updated versions of the manual to be downloaded to a mobile or tablet, for which it is necessary to have a QR code scanner app installed.

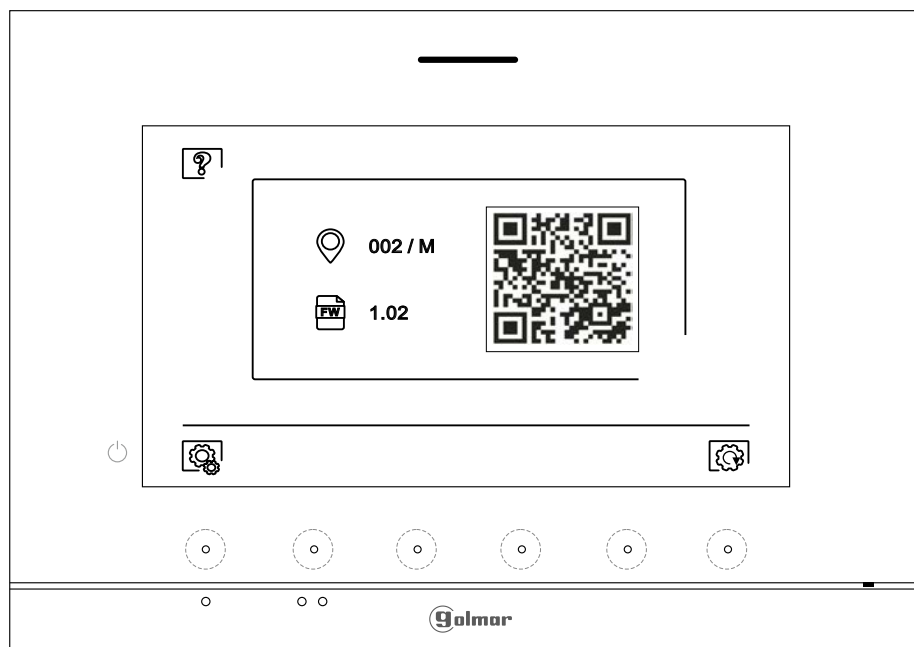
It enables the monitor to be restored to factory settings, such as melodies, call volume, etc.

Press the hidden button below icon  to return to the settings menu.



To restore the monitor to factory settings, press the hidden button below icon  to access the factory reset menu, then press the hidden button below icon  to perform this function. Press the hidden button below icon  to return to the 'About' screen. Press the hidden button below icon  to return to the settings menu.





Press the hidden button below icon  to return to the settings menu.

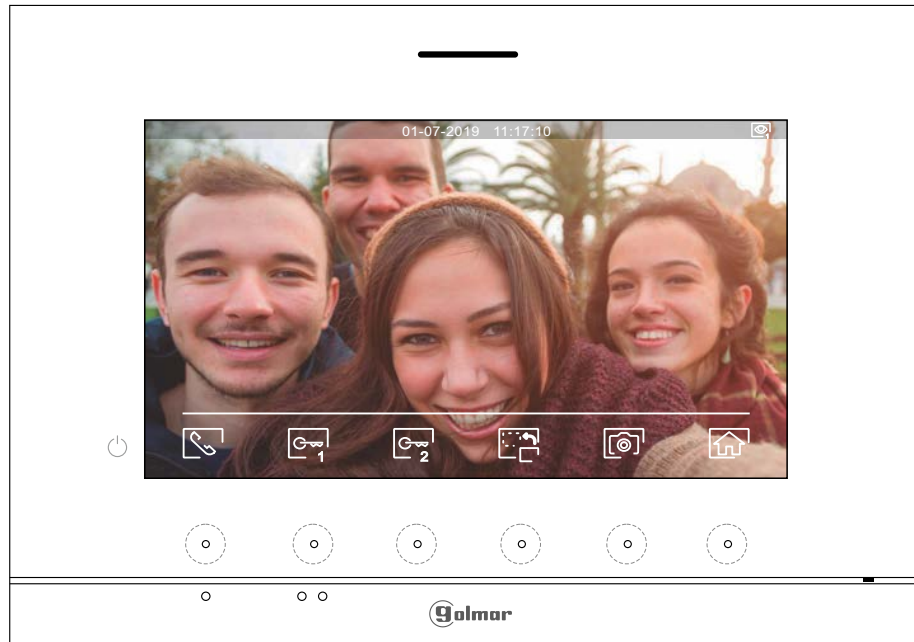

## ART 7/G2+ MONITOR

## Door panel call screen



This screen is displayed when you receive a call or when you press the hidden button below icon  of the main menu. During a call, icon  displayed on the screen will blink green (during the call process). In the top centre of the screen, the date and time are shown and, on the right, the source of the image is displayed (door panel 1, door panel 2, camera 1 or camera 2). The call has a duration of 45 seconds.





Press the hidden button below icon  to cancel the current call or display and return to the main menu.





Press the hidden button below icon  to change the source of the image as long as the system has more than one door panel or has an external camera connected and display has been activated (see pp. 32-34). It is possible to make the change during display, call and communication processes.





Press the hidden button below icon  /  to start or end audio communication with the door panel displayed respectively. Communication has a maximum duration of 90 seconds. Once communication has ended, the screen will turn off.









Press the hidden button below icon  to activate the lock release (or device connected to the CV output of the door panel) for 3 seconds (factory setting, programmable by the installer; see pp. 32-34). During activation, indicator  will illuminate.



Press the hidden button below icon  to activate the lock release (or device connected to the relay output of the door panel) for 3 seconds (factory setting, programmable by the installer; see pp. 32-34). During activation, indicator  will illuminate.



A few seconds after receiving a call, it automatically takes a photograph. In the top left of the screen, icon  is displayed and indicator  will illuminate. Press the hidden button below icon  to take a picture.

If a Micro SD card is inserted, a 15-second video automatically starts recording a few seconds after receiving the call. In the top left of the screen, icon  is displayed and indicator  will illuminate (see p. 14 to configure video recording mode). Then a short 1-second press on the hidden button below icon  will take a photograph or a long 2-second press will record a video.





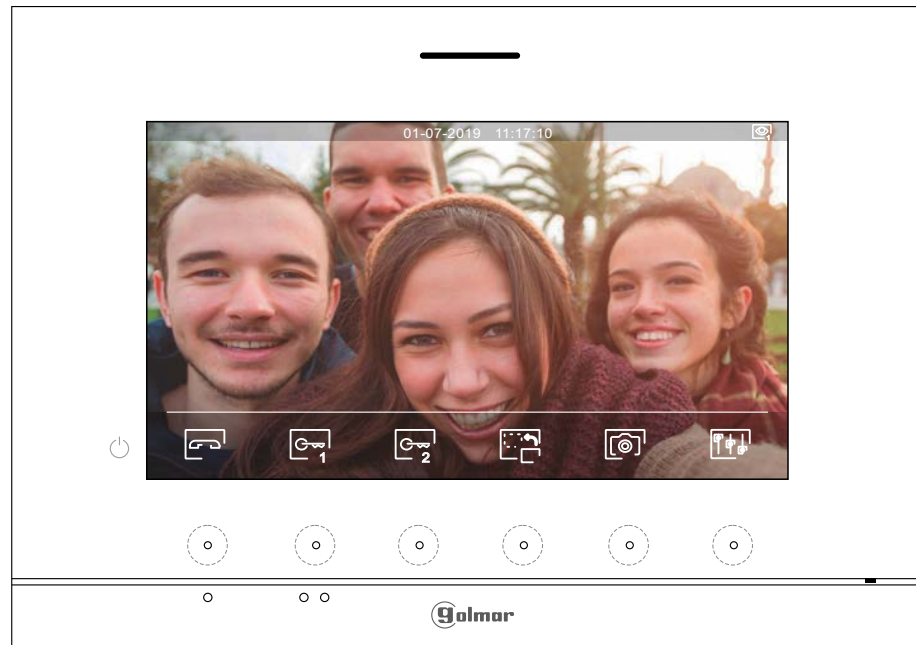

## ART 7/G2+ MONITOR

## Communication screen



This screen is displayed during a communication process. In the top centre of the screen, the date and time are shown and, on the right, the source of the image is displayed (door panel 1, door panel 2, camera 1 or camera 2).





Press the hidden button below icon  to access the image and monitor in communication volume settings menu. Go to the option to be modified by pressing the hidden buttons below corresponding icons  / , change to the desired level by pressing the hidden buttons below corresponding icons  /  and validate the changes made by pressing the hidden button below icon , (see p. 19).





Press the hidden button below icon  to change the source of the image as long as the system has more than one door panel or has an external camera connected and display has been activated (see pp. 32-34). This enables the door panel camera to be changed, the audio of the corresponding door panel to be activated and the door to be opened.





Press the hidden button below icon  /  to start or end audio communication with the door panel displayed respectively. Communication has a maximum duration of 90 seconds. Once communication has ended, the screen will turn off.







Press the hidden button below icon  to activate the lock release (or device connected to the CV output of the door panel) for 3 seconds (factory setting, programmable by the installer; see pp. 32-34). During activation, indicator  will illuminate.



Press the hidden button below icon  to activate the lock release (or device connected to the relay output of the door panel) for 3 seconds (factory setting, programmable by the installer; see pp. 32-34). During activation, indicator  will illuminate.



Press the hidden button below icon  to take a picture. In the top left of the screen, icon  is displayed.





Note: If a Micro SD card is inserted, a 15-second video automatically starts recording a few seconds after **receiving the call**. In the top left of the screen, icon  is displayed and indicator  will illuminate (see p. 14 to configure video recording mode). Then a short 1-second press on the hidden button below icon  will take a photograph or a long 2-second press will record a video.

ART 7/G2+ MONITOR

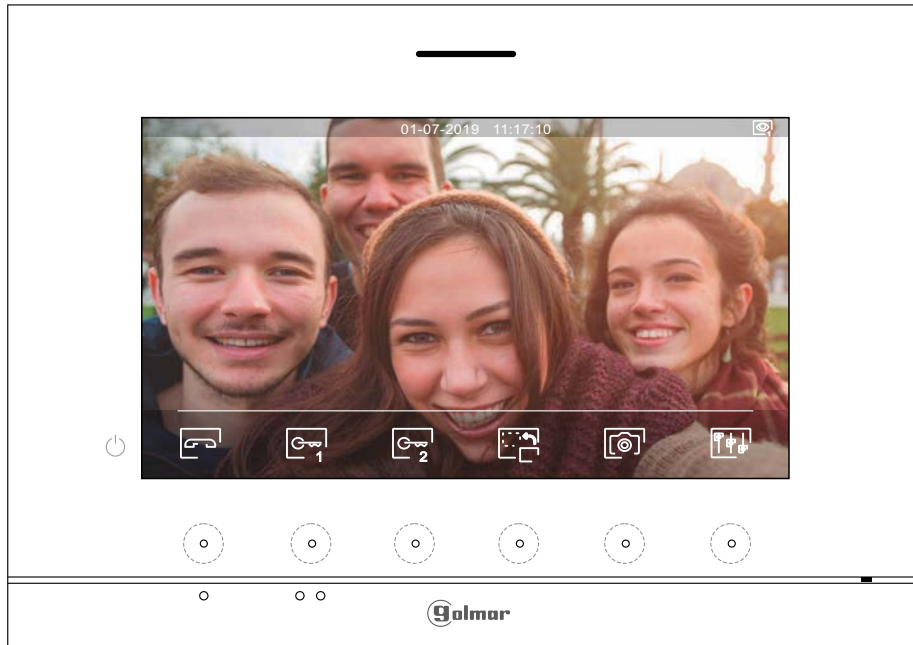
Image and communication settings

During a communication process, press the hidden button below icon  to access the image and monitor in communication volume settings menu



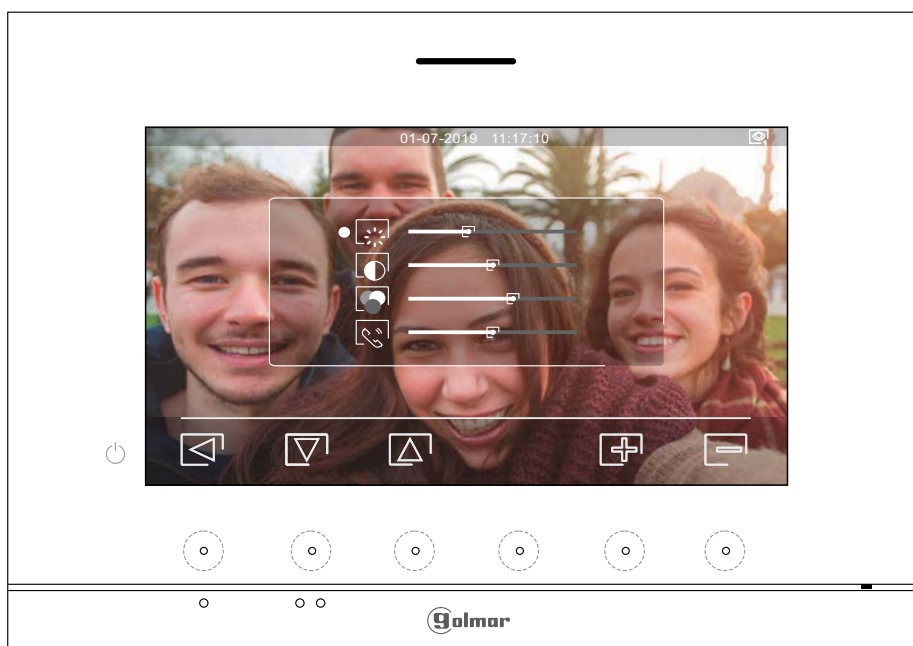

The following settings menu will then appear (brightness, contrast, colour and monitor in communication volume). Go to the option to be modified by pressing the hidden buttons below icons  /  and change to the desired level by pressing the hidden buttons below corresponding icons  / . To exit the screen settings and monitor volume menu and validate the changes made, press the button below icon .



ART 7/G2+ MONITOR

Intercom menu





Access the intercom menu as described on p. 11. From this menu, you can contact another monitor(s) in your apartment (internal intercom) or other apartments (external intercom). For external intercom, the monitor called must have its intercom function enabled from the 'Do not disturb' menu (factory setting: disabled).

Select option  or  to perform an internal or external intercom call.





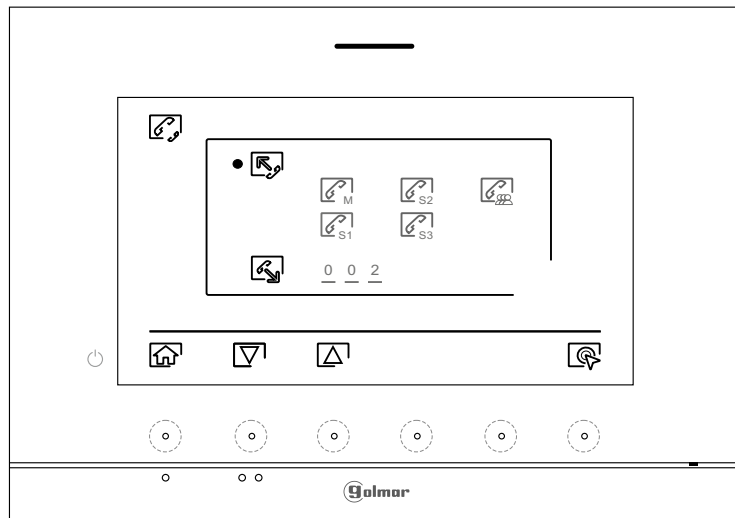

If during an intercom process with another monitor a call is received from the door panel, the intercom process will be terminated, and the door panel call will be received on the corresponding monitor.

Use icon  to return to the main menu.



**To make an internal intercom call (to another monitor(s) in the same apartment),** go to the option with icon  by pressing the hidden buttons below corresponding icons  /  and press the hidden button below icon  to access the monitor selection menu (in the same apartment). Note: You will find information about the monitor itself with the address, Master, Slave 1 to Slave 3 of the monitor in the 'About' menu, (see p. 16).



Then press the hidden buttons below icons  /  to select the monitor to call and press the hidden button below icon  to make the call. The monitor making the call will play a confirmation melody and indicate with a blink the monitor called. To cancel the call, press the hidden button below icon . Press the hidden button below icon  to return to the intercom menu. The monitor receiving the call will play a confirmation melody showing on screen with a blink the monitor making the call. Press the button below icon  to establish communication and press the hidden button below icon  to end communication.

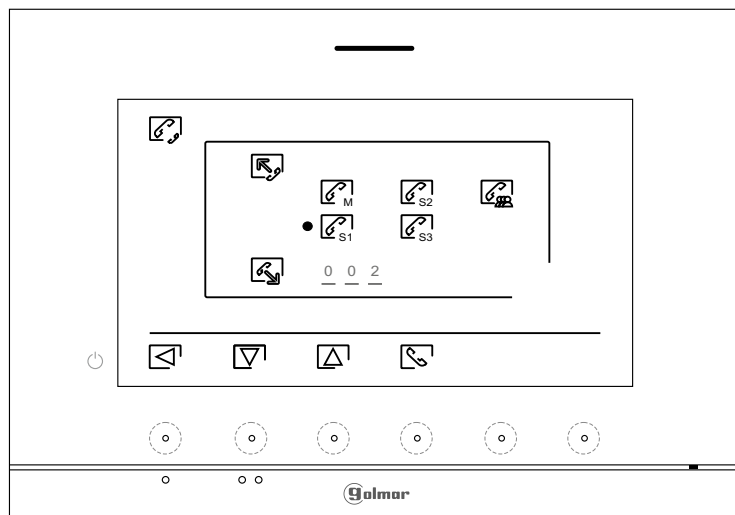





Continued from previous page.







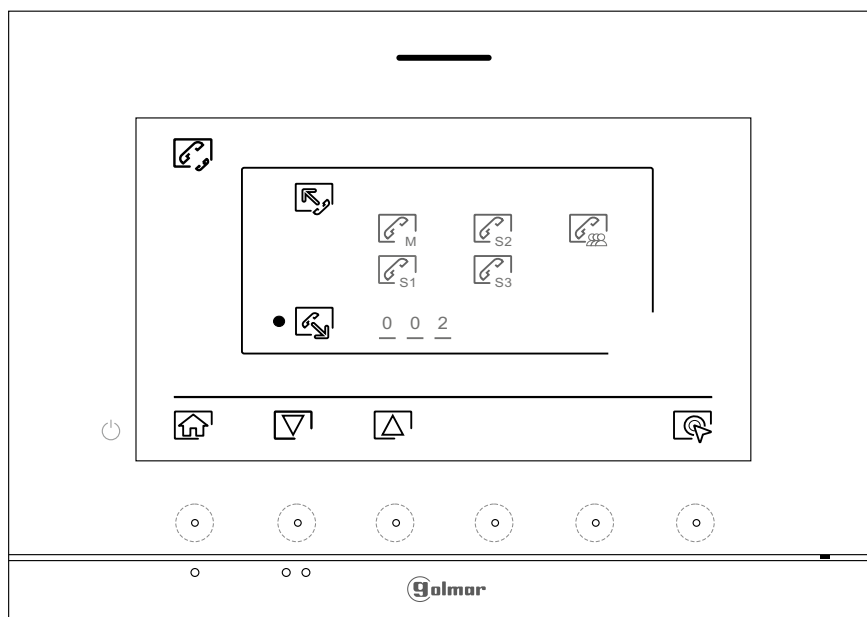

## ART 7/G2+ MONITOR

### Intercom menu



To make an external intercom call (to another monitor(s) in the same apartment), go to the option with icon  by pressing the hidden buttons below corresponding icons / and press the hidden button below icon  to access the code selection menu of the apartment with which you wish to communicate. (Intercom calls to other apartments are disabled by default, see p. 16).





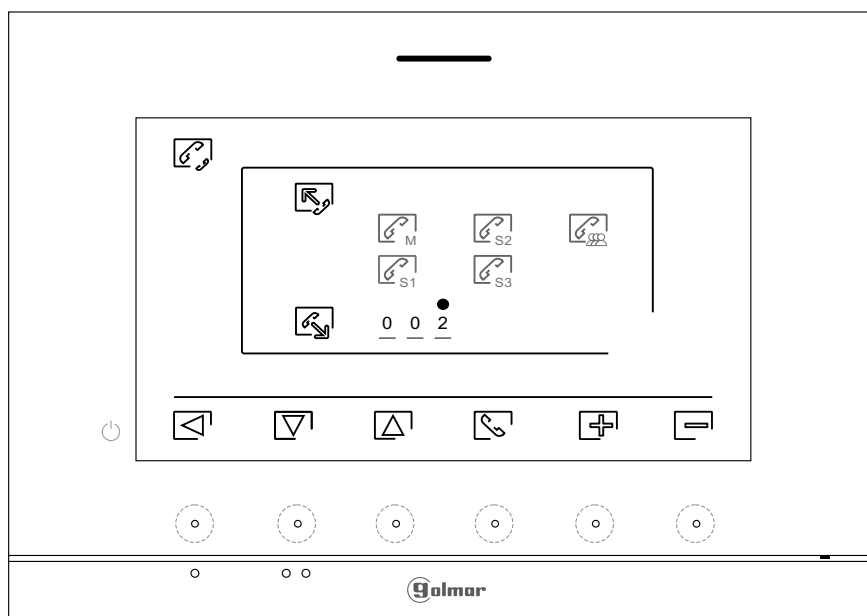

Press the hidden buttons below icons / to select the apartment code field to be modified, then press the hidden buttons below icons / to modify with the apartment code to be called and press the hidden button below icon  to make the call. The monitor making the call will play a confirmation melody and indicate with a blink the apartment called. To cancel the call, press the hidden button below icon . Press the hidden button below icon  to return to the intercom menu. The apartment receiving the call will play a confirmation melody showing on screen with a blink the apartment making the call. Press the button below icon  to establish communication and press the hidden button below icon  to end communication.







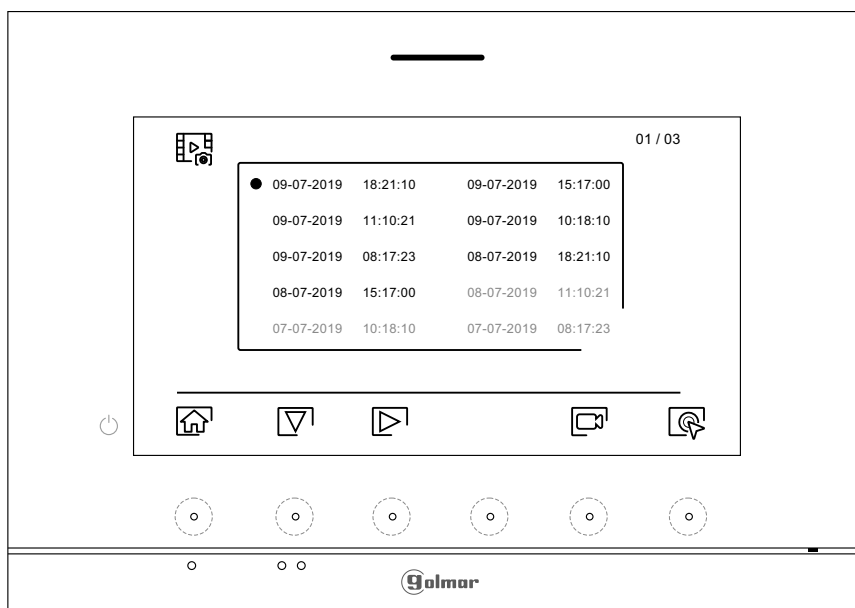

## ART 7/G2+ MONITOR

## Recordings menu

Access the recordings menu as described on p. 11. This menu displays the list of images saved in the memory of the device. If a Micro SD card is inserted in the monitor, images/videos will be recorded on the Micro SD card. Press the hidden button below icon  to access the list of videos saved on the Micro SD card. To return to the list of images, press the hidden button below icon . In the list of recorded images/videos, those that have not been viewed are highlighted in white. There are 10 recordings per page and the number of pages is shown in the top right of the screen. Press the hidden button below icon  to scroll the images/videos shown on the page and press the hidden button below icon  to go to the next page (in carousel mode). On the screen containing the list of images, press the hidden button under icon  to display the selected image.



The image is then displayed in full screen, the number of recordings is indicated in the top left and the recording source is shown on the right (door panel 1, door panel 2, camera 1 or camera 2). Press the hidden buttons below icons / to show the next or previous recording respectively. To delete the recording shown on screen, press the hidden button below icon  and then from the delete menu confirm the deletion of the recording by pressing the hidden button below icon  or press the hidden button below icon  to exit without deleting. To return to the list of images, press the hidden button below icon .

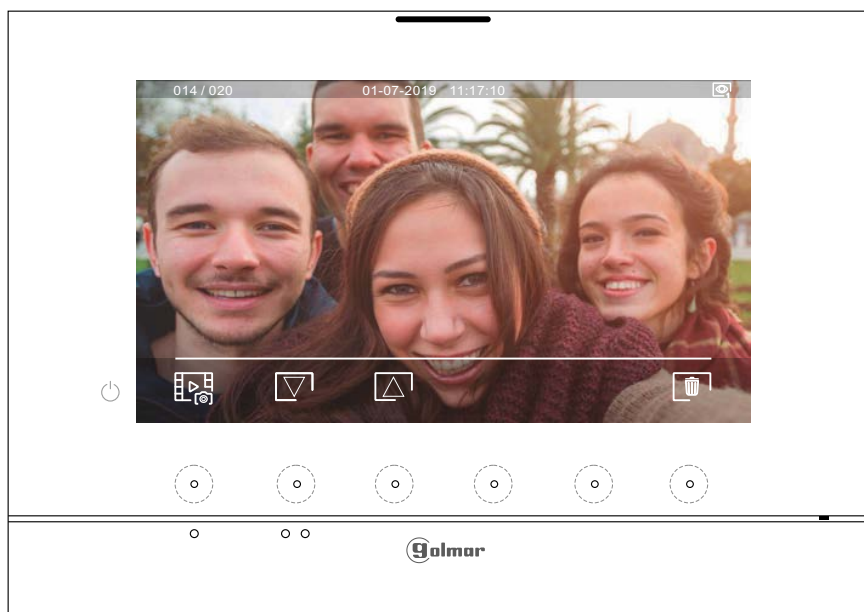





Continued overleaf







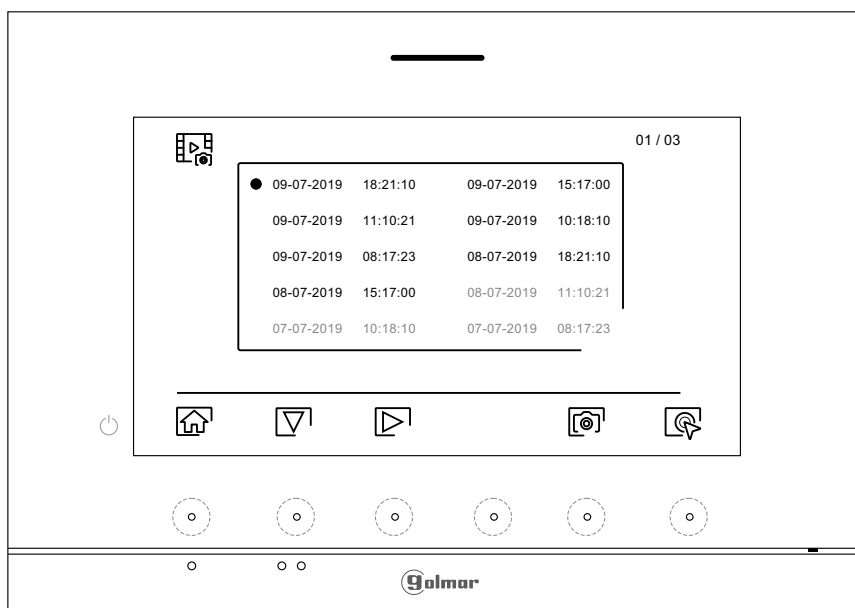

Continued from previous page.

## MONITOR ART 7/G2+

### Recordings menu

If a Micro SD card is inserted in the monitor, press the hidden button below icon  to access the list of videos. In the list of recorded videos, those that have not been viewed are highlighted in white. There are 10 recordings per page and the number of pages is shown in the top right of the screen. Press the hidden button below icon  to scroll the videos shown on the page and press the hidden button below icon  to go to the next page (in carousel mode). On the screen containing the list of videos, press the hidden button below icon  to display the video selected.



The video is then displayed in full screen, the number of recordings is indicated in the top left and the recording source is shown on the right (door panel 1, door panel 2, camera 1 or camera 2). Press the hidden buttons below icons / to show the next or previous recording respectively. To view the video shown on screen, press the hidden button below icon  and to stop video viewing, press the hidden button below icon . To delete the recording shown on screen, press the hidden button below icon  and then from the 'delete screen' confirm the deletion of the recording by pressing the hidden button below icon  or press the hidden button below icon  to exit without deleting. To return to the list of images, press the hidden button below icon .

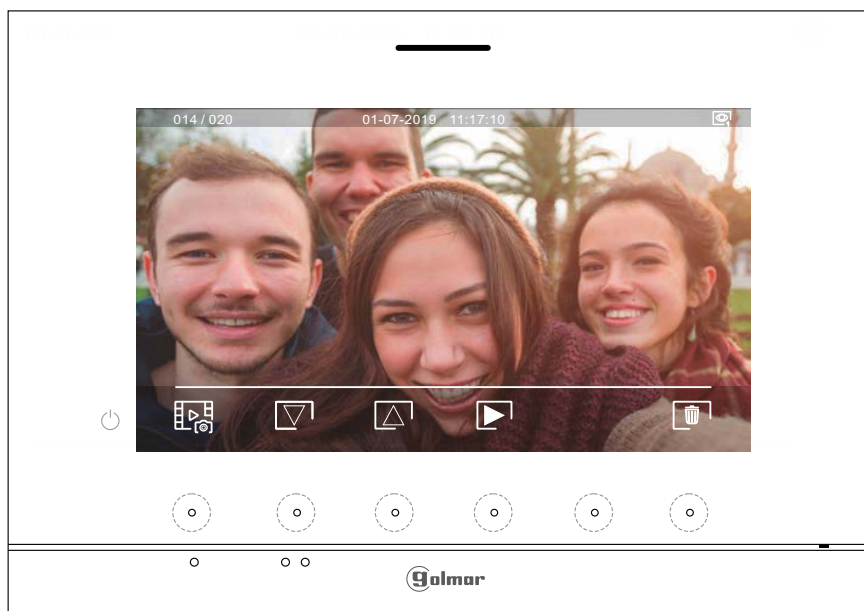

Continued overleaf

Continued from previous page.

**ART 7/G2+ MONITOR**

**Recordings menu**

To return to the main menu, press the hidden button below icon  .

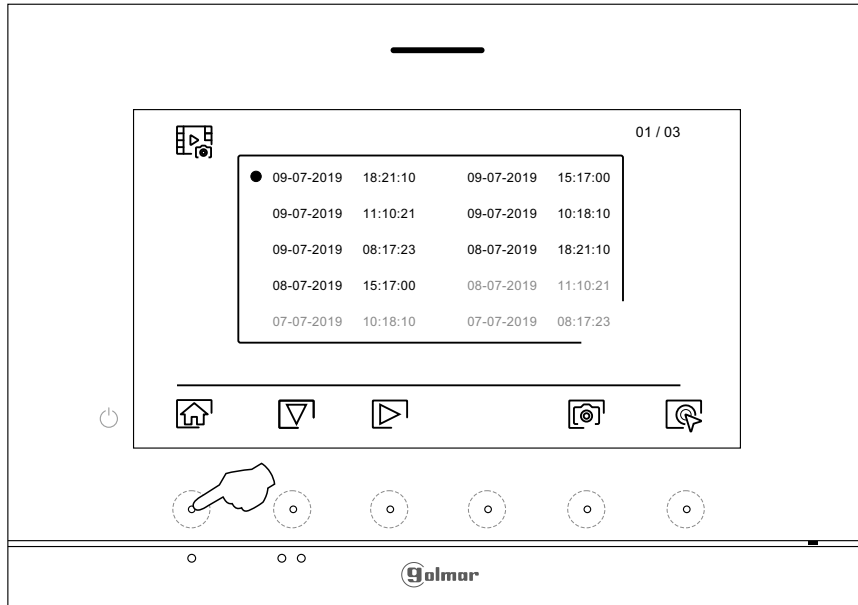

**Main menu**

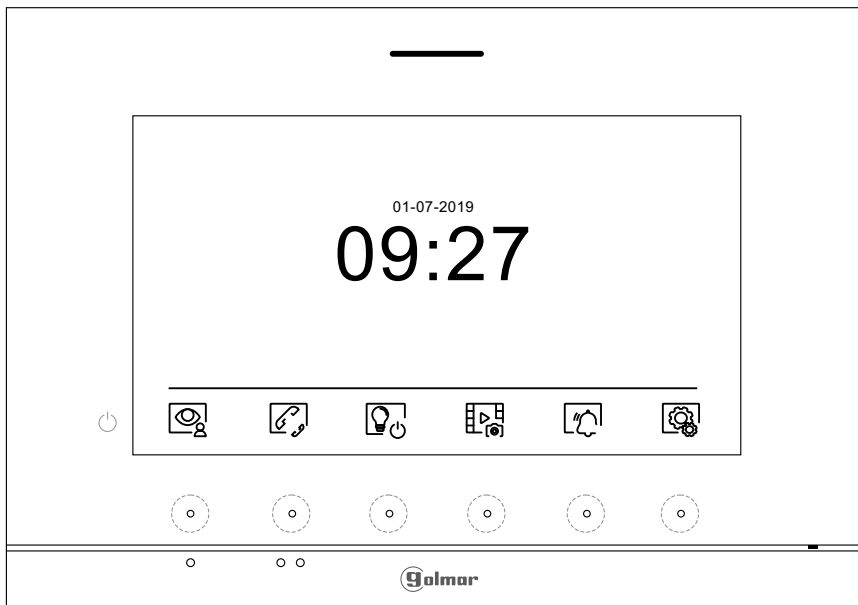



WIRING DIAGRAMS

Cross sections and distances

- The maximum number of monitors per apartment is 4.
- The maximum number of monitors in cascade is 12.

Type of cable	A	B	C
2 x 0.75mm <sup>2</sup> (AWG18)	30 m	30 m	15 m
CAT5 (*)	60 m	60 m	30 m
RAP-GTWIN/HF	60 m	60 m	30 m

- A. Distance between power supply and furthest door panel.
- B. Distance between power supply and furthest monitor (or distributor).
- C. Distance between a distributor and the furthest monitor connected to one of its outputs.

(\*). Use two twisted pairs for each bus line.

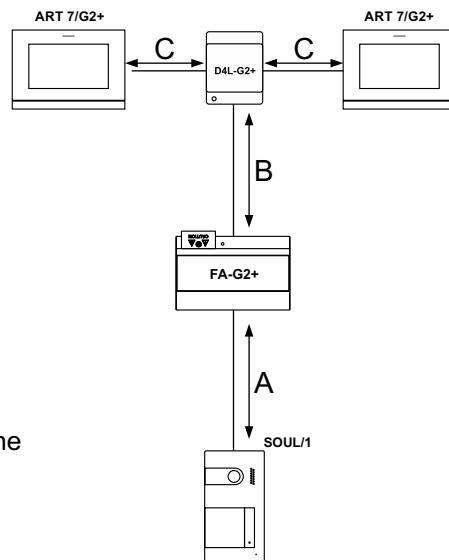

One apartment with one access panel and one monitor

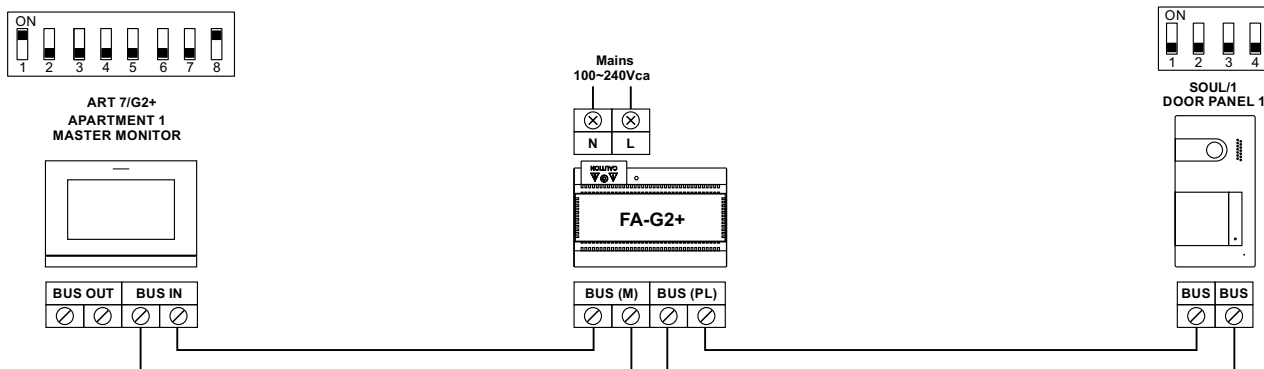

One apartment with two access panels and one monitor

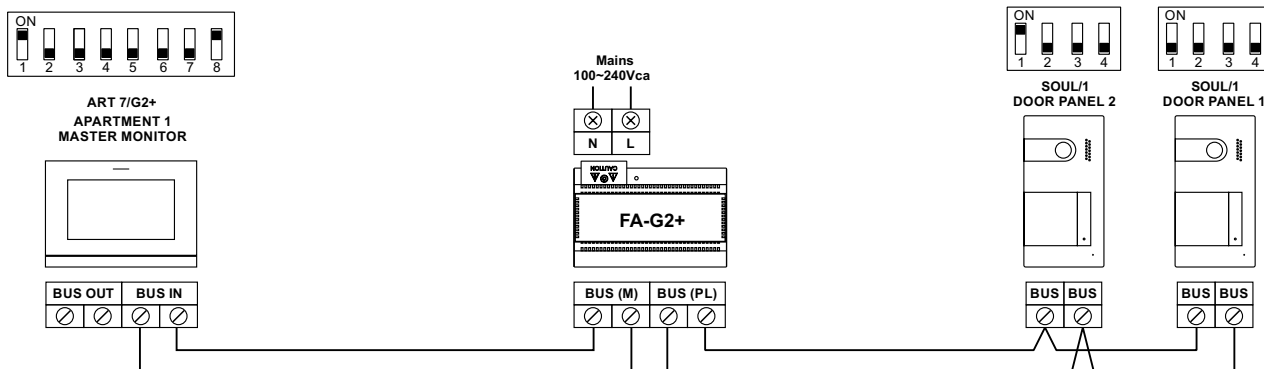

WIRING DIAGRAMS

One apartment with up to two access panels and up to four monitors in cascade

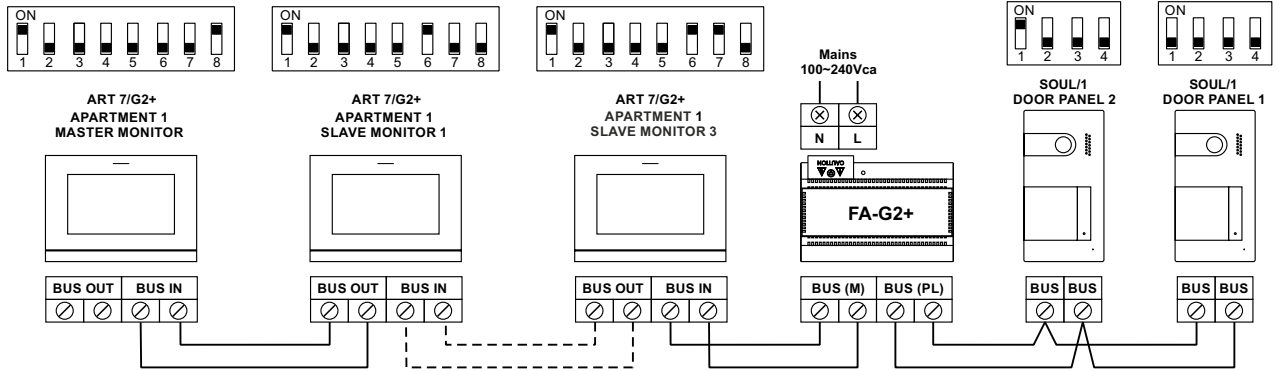

One apartment with up to two access panels and up to four monitors in distribution

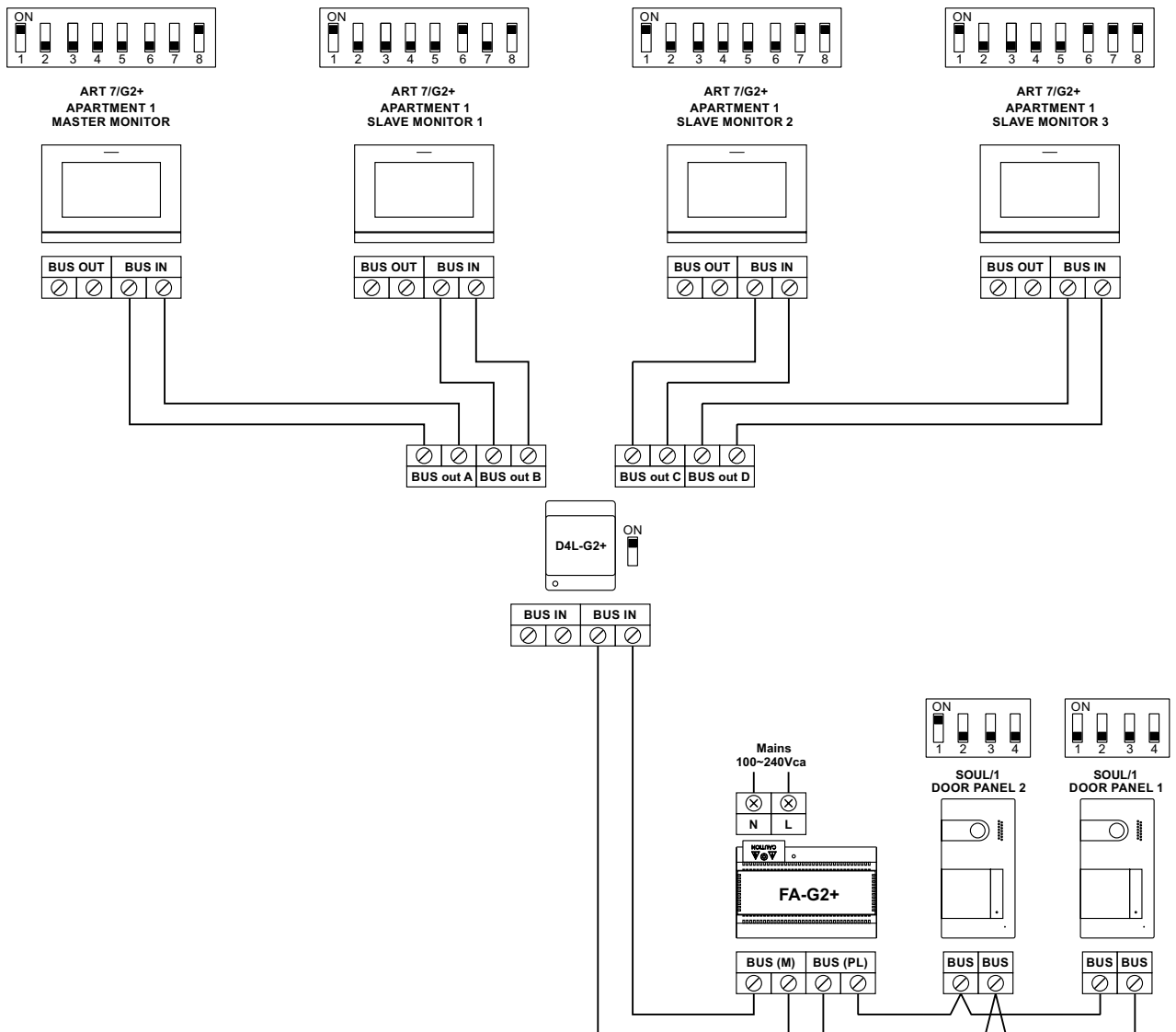

WIRING DIAGRAMS

Two apartments with up to two access panels and up to four monitors in cascade

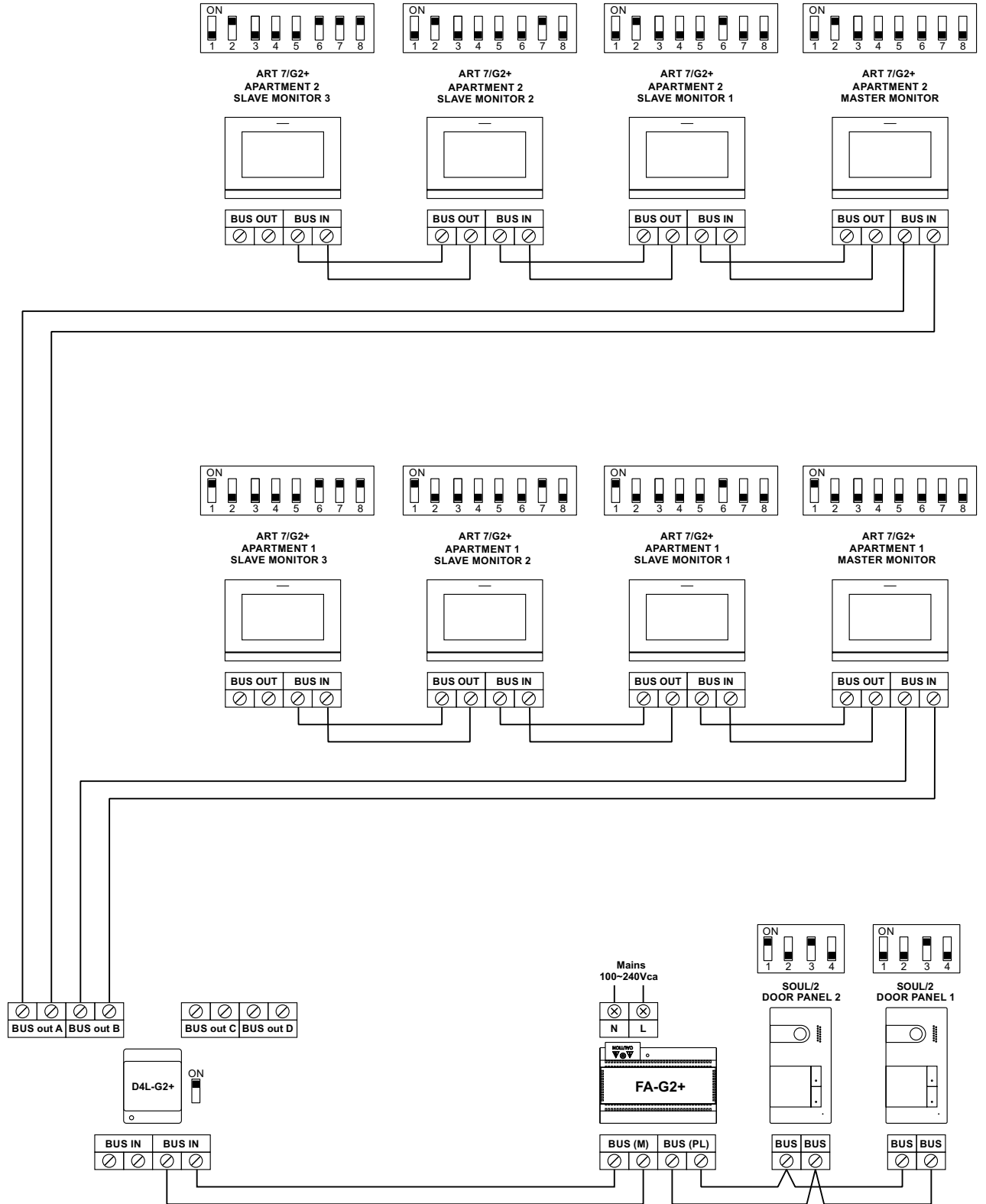

WIRING DIAGRAMS

Four apartments with up to two access panels and up to four monitors in cascade

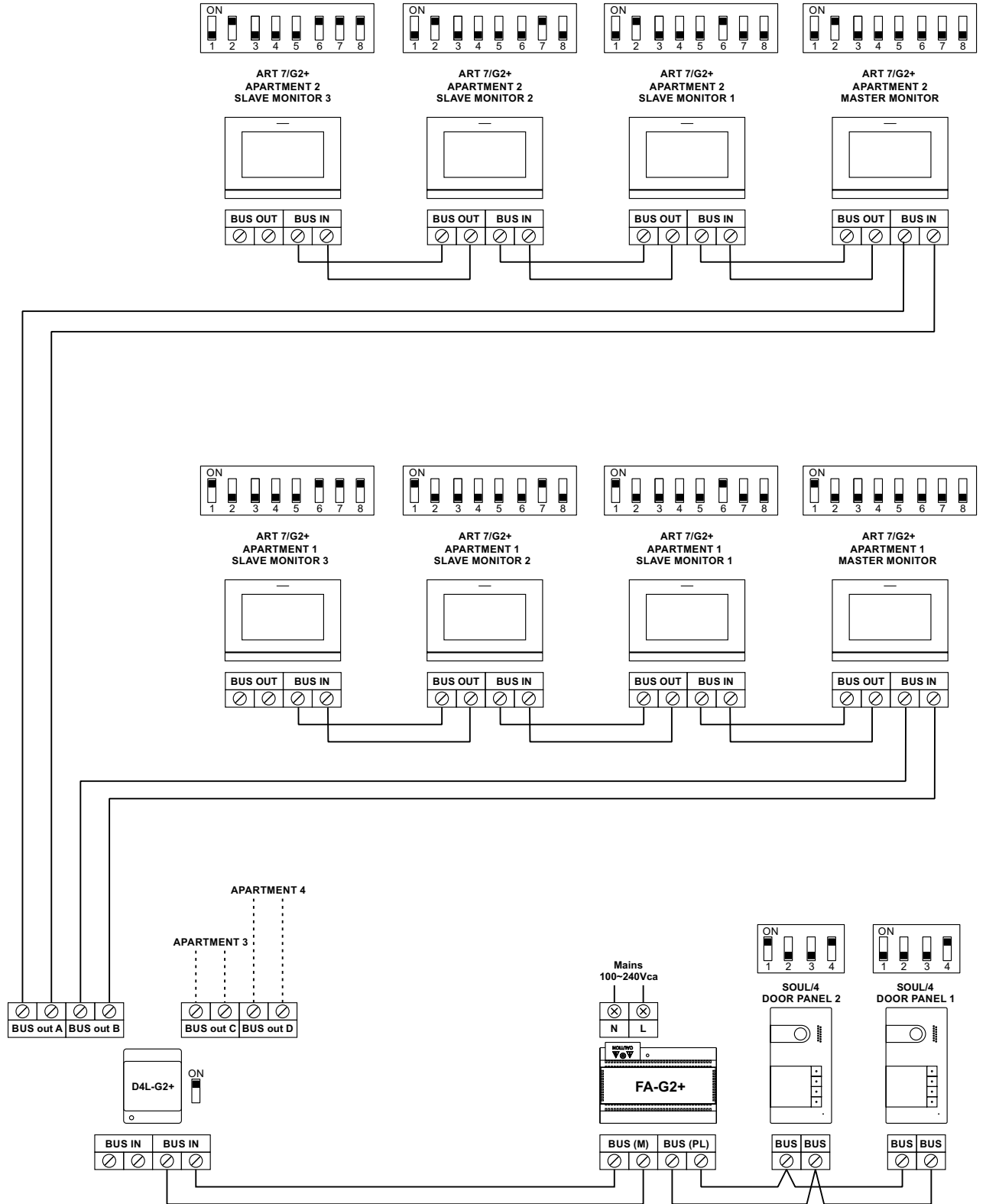

WIRING DIAGRAMS

Four apartments with up to four access panels and up to four monitors in cascade

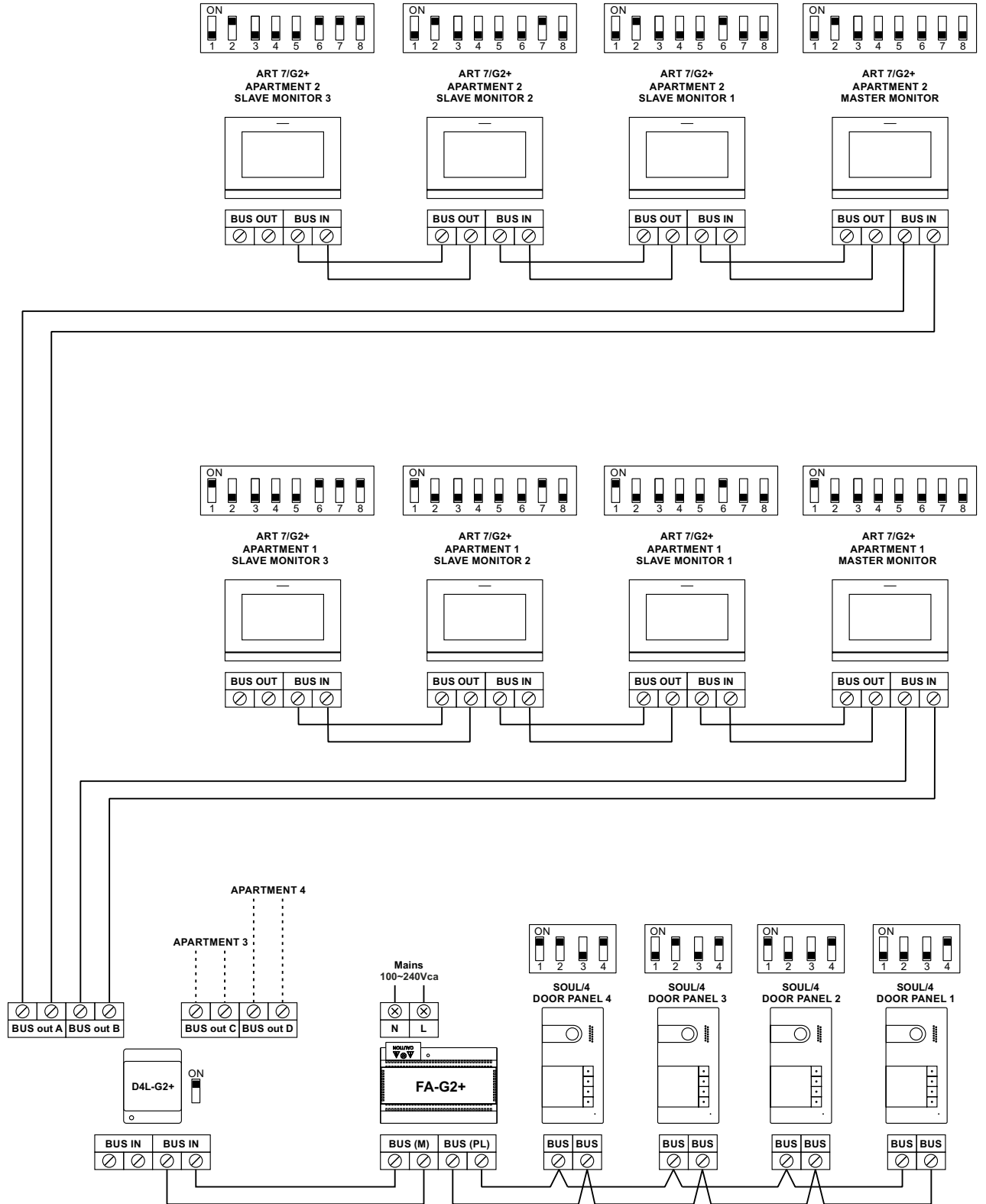

WIRING DIAGRAMS

Connection of a lock release

The drawing shows the connection of a 12Vdc lock release, with a maximum consumption of 270mA. The use of Golmar CV-14/DC, CV-24/DC, CV-14P/UNI or CV-24P/UNI models is recommended. Activation is carried out through icon .

The activation time is 3 seconds, with the possibility of setting it to between 0.5 and 10 seconds (see pp. 32-34).

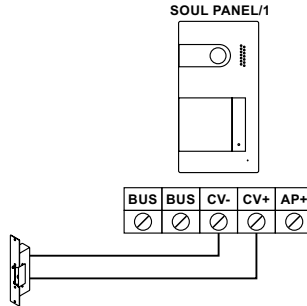

If the lock release to be used is alternating current, use a relay and transformer suitable for the consumption, as well as the varistor supplied. The example shows a Golmar SAR-12/24 relay and a TF-104 transformer (12Vac / 1.5A)

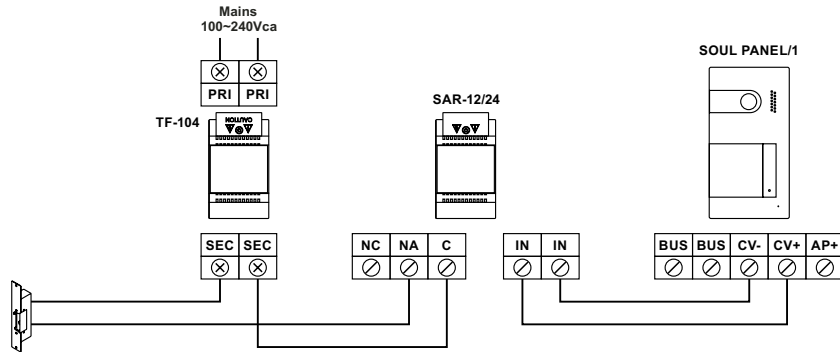

Connection of an auxiliary device at the relay output

The drawing, by way of example, shows the connection of a second AC lock release. The relay can switch 6A / 24V loads. Activation is carried out through icon .

The activation time is 3 seconds, with the possibility of setting it to between 0.5 and 10 seconds (see pp. 32-34).

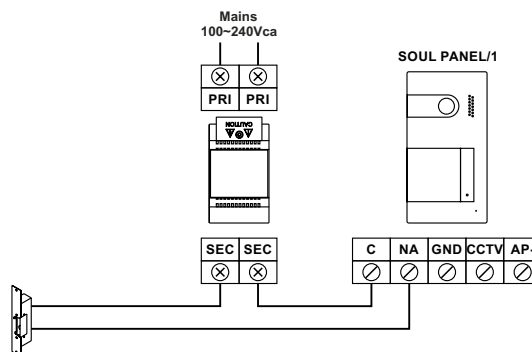

WIRING DIAGRAMS

Connection of an exit button

The exit button allows remote activation of the lock release connected between the CV- and CV+ terminals (by default) or the relay output (see p. 32-34). The delay time in carrying out the activation is 3 seconds, with the possibility of setting it to between 0.5 and 10 seconds (see pp. 32-34).

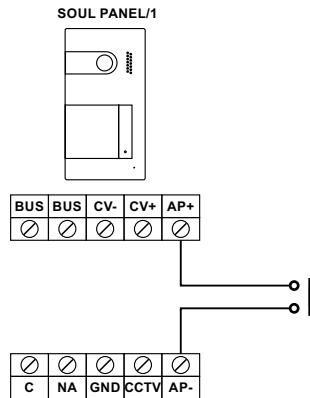

Connection of an external camera

It is possible to connect a Golmar AHD4-3601x analogue CCTV camera to each of the door panels, which can be viewed (see pp. 32-34) from the monitor. The camera needs to have a local PSU-121 power supply

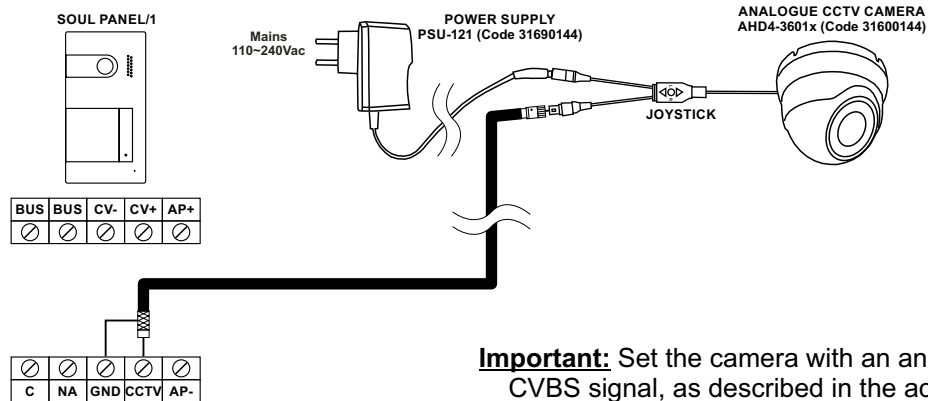

**Important:** Set the camera with an analogue CVBS signal, as described in the accompanying AHD4-3601x camera manual.

Connection for an apartment door button

Only connect the apartment door button to the master monitor of the apartment that will be receiving the call. The signal received is then transmitted to the slave monitors in the same apartment.

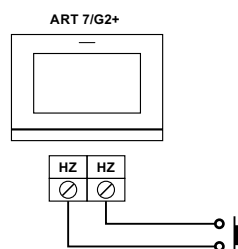

**SPECIAL CODES**

The enabling of some functions, as well as the modification of some factory parameters, can be carried out by entering special codes. To do so, the installer menu must be accessed from the monitor. Go to the 'About' screen in the Settings menu (p. 16) and press five times on the hidden button located above the raised dot for the visually impaired

●● .

'About' screen

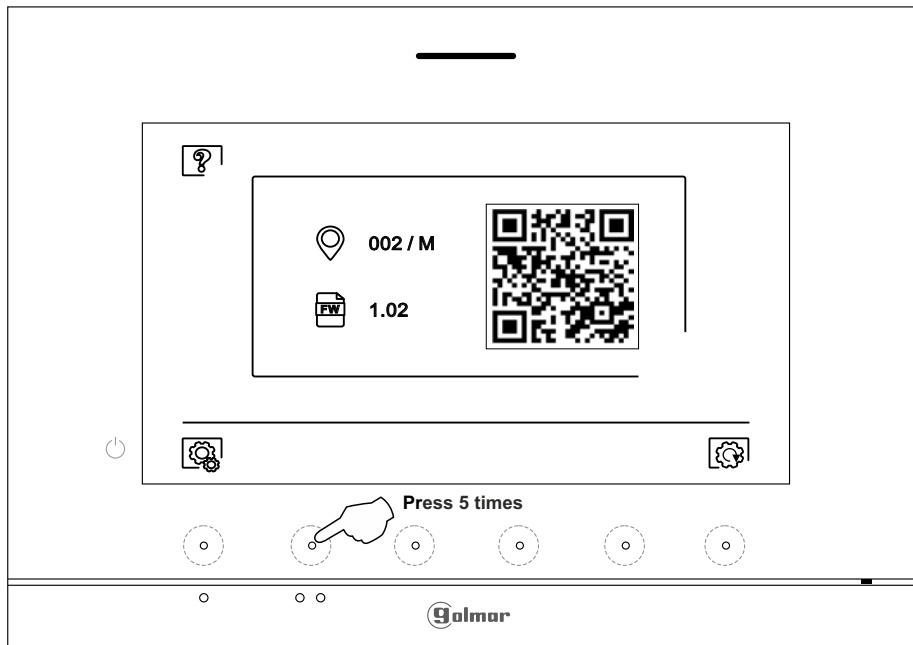

The 'special codes' screen will then be displayed. Press the hidden buttons below icons  $\nabla$  /  $\triangle$  to select the field to be modified and press the hidden buttons below icons  $\boxplus$  /  $\boxminus$  to enter the desired code. Once the code has been entered, press the hidden button below icon  $\checkmark$  to validate it. If the code entered is valid, icon  $\checkmark$  will be displayed; if it is not, icon  $\times$  will be shown.

Use icon  $\text{⚙}$  to return to the 'About' screen.

'Special codes' screen

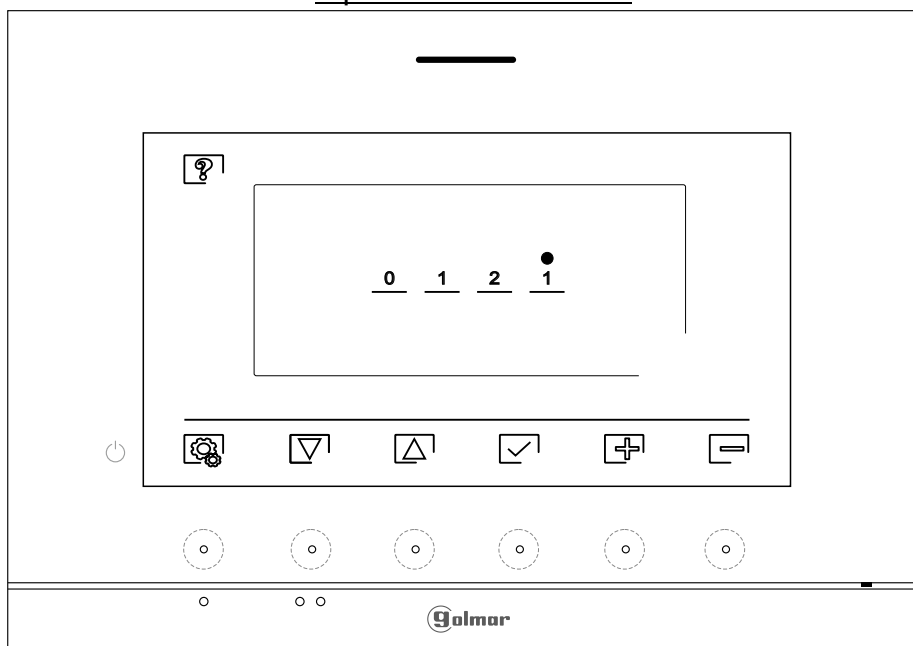



Continued from previous page.

## SPECIAL CODES

### Video sources available on a monitor (configure only on master monitor).

	<u>Visible</u>	<u>Not Visible</u>	<u>Factory setting</u>
Door panel 1	0111	0110	0111
Door panel 2	0121	0120	0120
(*) Door panel 3	0131	0130	0130
(*) Door panel 4	0151	0150	0150
Camera 1	0141	0140	0140
Camera 2	0181	0180	0180
(*) Camera 3	0171	0170	0170
(*) Camera 4	0191	0190	0190

(\*) Important: SOUL/1, SOUL/2 and SOUL/4 door panels with versión V04 or later.

### Automatic door opening upon reception of a call on a monitor (only setting on master monitor).

<u>Activated</u>	<u>Deactivated</u>	<u>Factory setting</u>
0441	0440	0440

### Activate/deactivate the ('power on indicator' notification icon) and (LEDs of the hidden buttons above the raised dots ●/●● for the visually impaired) on a monitor.

<u>Activate</u>	<u>Deactivate</u>	<u>Factory setting</u>
0471	0470	0471 (activated)

### Do not display the image on monitor when receiving a call from the door panel and the monitor is in "do not disturb" mode.

<u>Do not display</u>	<u>Display</u>	<u>Factory setting</u>
0481	0480	0480 (display image)

### Activation times of the outputs (Door panel 1). (Only setting on master monitor).

		<u>Factory setting</u>
Lock release	From 0200 (0.5s) to 0219 (10s)	0205 (3s)
Relay	From 0300 (0.5s) to 0319 (10s)	0305 (3s)

### Setting the remote activation button (Door panel 1). (Only setting on master monitor).

		<u>Factory setting</u>
Delay	From 0400 (0.5s) to 0419 (10s)	0403 (2s)
Output	0430 (lock release) or 0431 (relay)	0430 (lock release)

### Activation times of the outputs (Door panel 2). (Only setting on master monitor).

		<u>Factory setting</u>
Lock release	From 1200 (0.5s) to 1219 (10s)	1205 (3s)
Relay	From 1300 (0.5s) to 1319 (10s)	1305 (3s)

### Setting the remote activation button (Door panel 2). (Only setting on master monitor).

		<u>Factory setting</u>
Delay	From 1400 (0.5s) to 1419 (10s)	1403 (2s)
Output	1430 (lock release) or 1431 (relay)	1430 (lock release)

Continued from previous page.

## SPECIAL CODES

### **(\*) Activation times of the outputs (Door panel 3). (Only setting on master monitor).**

		<u>Factory setting</u>
Lock release	From 2200 (0.5s) to 2219 (10s)	2205 (3s)
Relay	From 2300 (0.5s) to 2319 (10s)	2305 (3s)

### **(\*) Setting the remote activation button (Door panel 3). (Only setting on master monitor).**

		<u>Factory setting</u>
Delay	From 2400 (0.5s) to 2419 (10s)	0403 (2s)
Output	2430 (lock release) or 2431 (relay)	0430 (lock release)

### **(\*) Activation times of the outputs (Door panel 4). (Only setting on master monitor).**

		<u>Factory setting</u>
Lock release	From 3200 (0.5s) to 3219 (10s)	3205 (3s)
Relay	From 3300 (0.5s) to 3319 (10s)	3305 (3s)

### **(\*) Setting the remote activation button (Door panel 4). (Only setting on master monitor).**

		<u>Factory setting</u>
Delay	From 3400 (0.5s) to 3419 (10s)	3403 (2s)
Output	3430 (lock release) or 3431 (relay)	3430 (lock release)

### **Night vision illuminaton leds (Door panel 1), during call or communication process. (Only setting on master monitor).**

<u>Automatic</u>	<u>Always ON</u>	<u>Always OFF</u>	<u>Factory setting</u>
0450	0451	0452	0450 (automatic).

### **Night vision illuminaton leds (Door panel 2), during call or communication process. (Only setting on master monitor).**

<u>Automatic</u>	<u>Always ON</u>	<u>Always OFF</u>	<u>Factory setting</u>
1450	1451	1452	1450 (automático).

### **(\*) Night vision illuminaton leds (Door panel 3), during call or communication process. (Only setting on master monitor).**

<u>Automatic</u>	<u>Always ON</u>	<u>Always OFF</u>	<u>Factory setting</u>
2450	2451	2452	2450 (automático).

### **(\*) Night vision illuminaton leds (Door panel 4), during call or communication process. (Only setting on master monitor).**

<u>Automatic</u>	<u>Always ON</u>	<u>Always OFF</u>	<u>Factory setting</u>
3450	3451	3452	3450 (automático).

### **Activate/ deactivate the ring tone (Door panel1). (Only setting on master monitor):**

<u>Activated</u>	<u>Deactivated</u>	<u>Factory setting</u>
1701	1700	1701

### **Activate/ deactivate the ring tone (Door panel 2). (Only setting on master monitor):**

<u>Activated</u>	<u>Deactivated</u>	<u>Factory setting</u>
2701	2700	2701

### **(\*) Activate/ deactivate the ring tone (Door panel 3). (Only setting on master monitor):**

<u>Activated</u>	<u>Deactivated</u>	<u>Factory setting</u>
3701	3700	3701

### **(\*) Activate/ deactivate the ring tone (Door panel 4). (Only setting on master monitor):**

<u>Activated</u>	<u>Deactivated</u>	<u>Factory setting</u>
4701	4700	4701

**CLEANING THE MONITOR**

---

- Do not use solvents, detergents or cleaning products that contain acids, vinegar or abrasive components.
- Use a soft, damp cloth (not wet) that does leave lint behind.
- Always wipe the monitor in the same direction, from top to bottom.
- After cleaning the monitor, remove any moisture with a soft dry cloth that sheds no fibres.

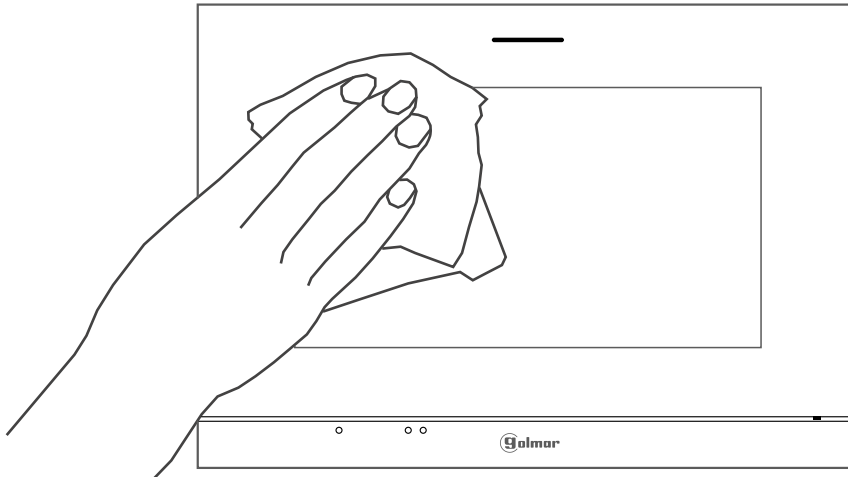
**CLEANING THE DOOR PANEL**

---

- Do not use solvents, detergents or cleaning products that contain acids, vinegar or abrasive components.
- Use a soft, damp cloth (not wet) that does leave lint behind.
- Always wipe the door panel in the same direction, from top to bottom.
- After cleaning the door panel, remove any moisture with a soft dry cloth that sheds no fibres.

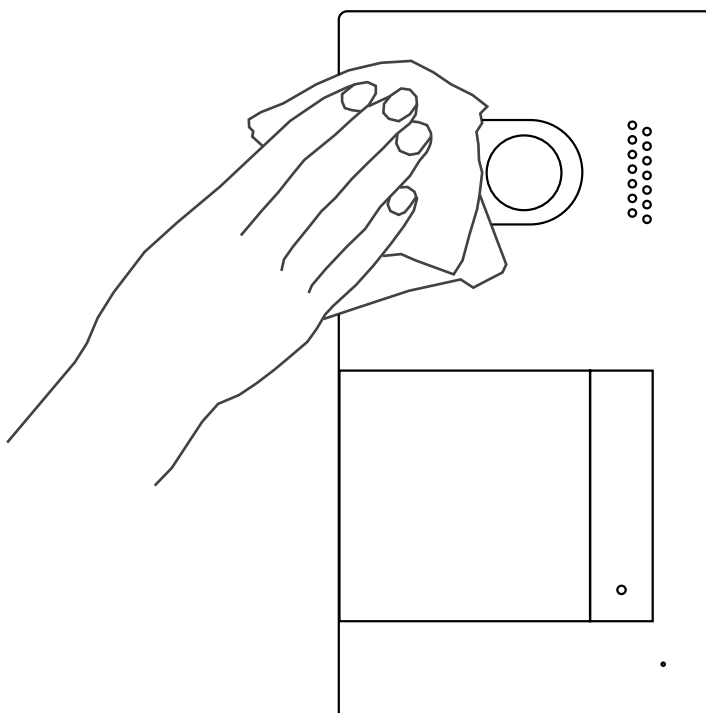

**COMPLIANCE:**

Este producto es conforme con las disposiciones de las Directivas Europeas aplicables respecto a la Seguridad Eléctrica **2014/35/CEE** y la Compatibilidad Electromagnética **2014/30/CEE**.

*This product meets the essentials requirements of applicable European Directives regarding Electrical Safety **2014/35/ECC** and Electromagnetic Compatibility **2014/30/ECC**.*



**NOTA:** El funcionamiento de este equipo está sujeto a las siguientes condiciones:

(1) Este dispositivo no puede provocar interferencias dañinas, y (2) debe aceptar cualquier interferencia recibida, incluyendo las que pueden provocar un funcionamiento no deseado.

**NOTE:** Operation is subject to the following conditions:

(1) This device may not cause harmful interference, and (2) this device must accept any received interference, including the ones that may cause undesired operation.



*Delton*

<b>1141 Budapest, Fogarasi út 77.</b>	<b>1095 Budapest, Mester utca 34.</b>
Tel.: *220-7940, 220-7814, 220-7959,	Tel.: *218-5542, 215-9771, 215-7550,
220-8881, 364-3428 Fax: 220-7940	216-7017, 216-7018 Fax: 218-5542
Mobil: 30 531-5454, 30 939-9989	Mobil: 30 940-1970, 30 959-0930

**www.golmar.hu**

E-mail: [info@delton.hu](mailto:info@delton.hu) Web: [www.delton.hu](http://www.delton.hu)



Golmar se reserva el derecho a cualquier modificación sin previo aviso.  
Golmar se réserve le droit de toute modification sans préavis.  
Golmar reserves the right to make any modifications without prior notice.